



KRONOS

KRONOS foldable boxes have been designed and manufactured to significantly reduce the overall space occupied when not in use and during transport of empties. Their volume reduction of up to 75% therefore leads to high savings in storage and transport costs. KRONOS foldable boxes are equipped with a sturdy stacking edge and ribbed outer walls at the highest stress points:

these structural features give the boxes extra durability over time.

Lightweight and manageable, they adapt perfectly to normalised pallets. Their flat bottoms allow use on all types of roller beds, thus giving great flexibility also in internal handling.

The short sides are supplied with handy label holders and comfort handles for easy grip; the handles can be closed with the use of special casings.

handle closure casing



When used with the lid, the box can be fastened shut with disposable seals that are also customisable: the seals are applied on the two-flap lid and on the opening mechanism positioned on the two short sides of the box.

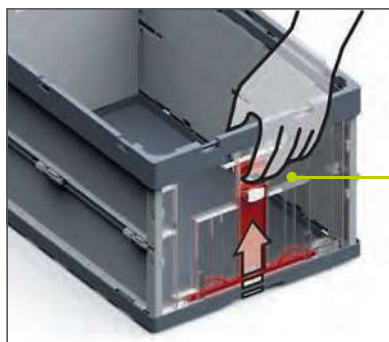

Clamping system

FOLDABILITY

1



2



3



4



DIMENSIONS

400 x 300 x 220 H mm



600 x 400 x 220 H mm



600 x 400 x 320 H mm



600 x 400 x 420 H mm



800 x 400 x 420 H mm



FRAME COLOR CUSTOMIZATION ON REQUEST

MINIMUM OF 200 PIECES (with surcharge)



H 220/320 = 80 mm
 H 420 = 100 mm

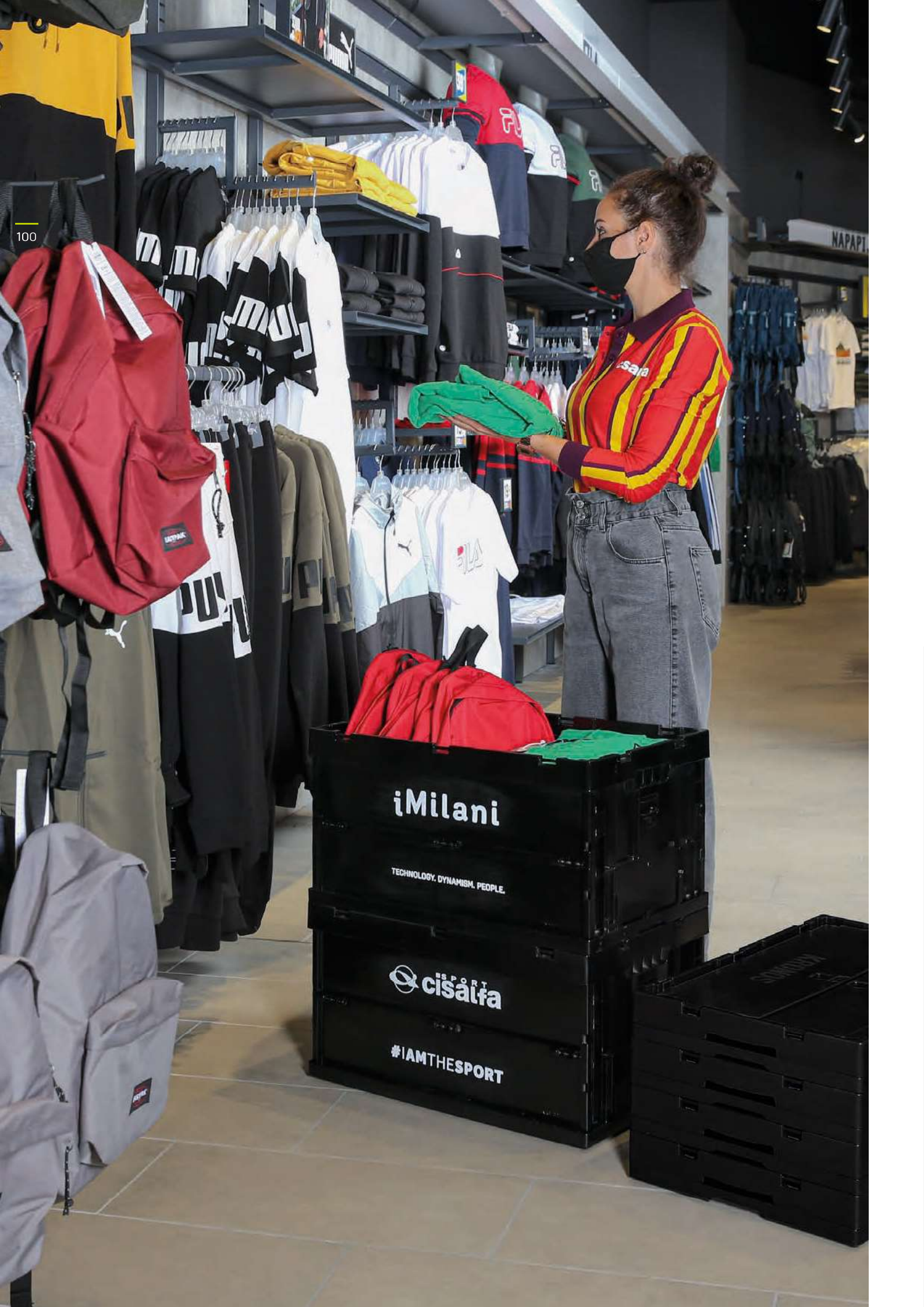

iMilani

TECHNOLOGY. DYNAMISM. PEOPLE.

 cisalfa
SPORT

#IAMTHESPORT

NAPART

400 x 300 mm H 220 mm

iMICUBE

	ARTICLE	WALLS		BOTTOM			HANDLES		GR.	PACKAGING		UNIT PRICE €
		Closed	Perforated	Closed	Perforated	Reinforced	Closed	Open		Qty. per pack.	Qty. per pallet	
B	KR 4322B 5101	■		■			■		1510	10	240	
ACCESSORIES												
1	KR 43HG 51XL								277	5	700	
2	KR PLUG 5101								18	10		
3	KR SEAL 5113									500		



B

Closed bottom
Load capacity 20 kg

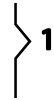

1

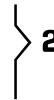

2



3

DATASHEET

B	
Height closed	80 mm
Stacked edge height closed	72 mm
Stacked edge height open	212 mm
Usable stacked height / with lid	202 mm / 202 mm
Usable internal dimensions	354 x 256 x 216 H mm
Maximum stacking load capacity	160 kg
Volume	20 L
Pieces per pack / pallet	10 240
Package dimensions	620 x 420 x 388 H mm
Pallet dimensions	1200 x 800 x 2318 H mm

1	
Lid	400 x 300 mm
Pieces per pack. / dimension	5 / 410 x 180 x 150 H mm
Pieces per pallet / dimension	700 / 1200 x 800 x 870 H mm

2	
Handle closure casing	
Pieces per pack	10

3	
Disposable security seal	
Pieces per pack	500

THE LIDS ARE SUPPLIED SEPARATELY

iMilani srl reserves the right to alter the characteristics of products without notice. The values shown are nominal, with a +/- 1% tolerance for size, depending on the material, and a +/- 3% for weight.



ARTICLE	WALLS		BOTTOM			HANDLES		GR.	PACKAGING		UNIT PRICE €
	Closed	Perforated	Closed	Perforated	Reinforced	Closed	Open		Qty. per pack.	Qty. per pallet	
B KR 6422B 5101	■		■			■		2192	5	120	
ACCESSORIES											
1 KR 64HG 51XL								590	5	350	
2 KR PLUG 5101								18	10		
3 KR SEAL 5113									500		

B	
Height closed	80 mm
Stacked edge height closed	72 mm
Stacked edge height open	212 mm
Usable stacked height / with lid	202 mm / 202 mm
Usable internal dimensions	554 x 356 x 216 H mm
Maximum stacking load capacity	160 kg
Volume	40 L
Pieces per pack / pallet	5 120
Package dimensions	620 x 420 x 388 H mm
Pallet dimensions	1200 x 800 x 2318 H mm
1	
Lid	600 x 400 mm
Pieces per pack. / dimension	5 / 610 x 250 x 150 H mm
Pieces per pallet / dimension	350 / 1200x800x870Hmm
2	
Handle closure casing	
Pieces per pack	10
3	
Disposable security seal	
Pieces per pack	500

DATASHEET

THE LIDS ARE SUPPLIED SEPARATELY

600 x 400 mm H 320 mm

iMICUBE

ARTICLE	WALLS		BOTTOM			HANDLES		GR.	PACKAGING		UNIT PRICE €
	Closed	Perforated	Closed	Perforated	Reinforced	Closed	Open		Qty. per pack.	Qty. per pallet	
B KR 6432B 5101	■		■			■		2780	5	120	
ACCESSORIES											
1 KR 64HG 51XL								590	10	180	
2 KR PLUG 5101								18	10		
3 KR SEAL 5113									500		



Closed bottom
Load capacity 20 kg

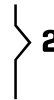
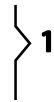

DATASHEET

B

Height closed	80 mm
Stacked edge height closed	72 mm
Stacked edge height open	312 mm
Usable stacked height / with lid	302 mm / 302 mm
Usable internal dimensions	554 x 356 x 316 H mm
Maximum stacking load capacity	160 kg
Volume	60 L
Pieces per pack / pallet	📦 5 🚚 120
Package dimensions	620 x 420 x 388 H mm
Pallet dimensions	1200 x 800 x 2318 H mm

1

Lid	600 x 400 mm
Pieces per pack. / dimension	📦 10 / 620 x 250 x 180 H mm
Pieces per pallet / dimension	🚚 180 / 1240 x 800 x 670 H mm

2

Handle closure casing	
Pieces per pack	📦 10

3

Disposable security seal	
Pieces per pack	📦 500

THE LIDS ARE SUPPLIED SEPARATELY

iMilani srl reserves the right to alter the characteristics of products without notice. The values shown are nominal, with a +/- 1% tolerance for size, depending on the material, and a +/- 3% for weight.

600 x 400 mm H 420 mm

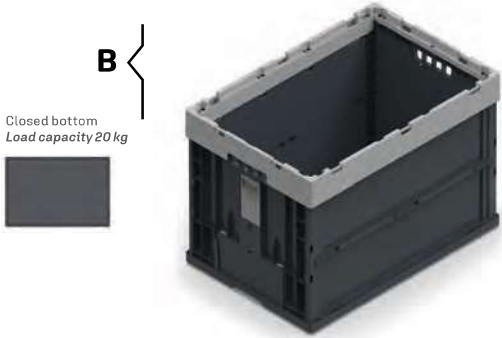

ARTICLE	WALLS		BOTTOM			HANDLES		GR.	PACKAGING		UNIT PRICE €
	Closed	Perforated	Closed	Perforated	Reinforced	Closed	Open		Qty. per pack.	Qty. per pallet	
B KR 6442B 5101	■		■				■	4010	4	96	
ACCESSORIES											
1 KR 64HG 51XL								590	10	180	
2 KR PLUG 5101								18	10		
3 KR SEAL 5113									500		

B	
Height closed	100 mm
Stacked edge height closed	92 mm
Stacked edge height open	412 mm
Usable stacked height / with lid	402 mm / 402 mm
Usable internal dimensions	554 x 356 x 416 H mm
Maximum stacking load capacity	160 kg
Volume	80 L
Pieces per pack / pallet	4 96
Package dimensions	620 x 420 x 411 H mm
Pallet dimensions	1200 x 800 x 2346 H mm
1	
Lid	600 x 400 mm
Pieces per pack. / dimension	10/ 620 x 250 x 180 H mm
Pieces per pallet / dimension	180/ 1240x800x670 H mm
2	
Handle closure casing	
Pieces per pack	10
3	
Disposable security seal	
Pieces per pack	500

DATASHEET

THE LIDS ARE SUPPLIED SEPARATELY

iMilani srl reserves the right to alter the characteristics of products without notice. The values shown are nominal, with a +/- 1% tolerance for size, depending on the material, and a +/- 3% for weight.

800 x 400 mm H 420 mm

iMICUBE

ARTICLE	WALLS		BOTTOM			HANDLES		GR.	PACKAGING		UNIT PRICE €
	Closed	Perforated	Closed	Perforated	Reinforced	Closed	Open		Qty. per pack.	Qty. per pallet	
B KR 8442B 5101	■		■			■		4891	4	72	
ACCESSORIES											
1 KR 64HG 51XL								808	10	200	
2 KR PLUG 5101								18	10		
3 KR SEAL 5113									500		



Closed bottom
Load capacity 20 kg

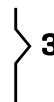
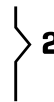
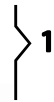

DATASHEET

B	
Height closed	100 mm
Stacked edge height closed	92 mm
Stacked edge height open	412 mm
Usable stacked height / with lid	402 mm / 402 mm
Usable internal dimensions	754 x 356 x 416 H mm
Maximum stacking load capacity	160 kg
Volume	100 L
Pieces per pack / pallet	📦 4 🚚 72
Package dimensions	820 x 420 x 411 H mm
Pallet dimensions	1200 x 800 x 2346 H mm

1	
Lid	800 x 400 mm
Pieces per pack. / dimension	📦 10 / 820 x 250 x 180 H mm
Pieces per pallet / dimension	🚚 200 / 1250 x 820 x 850 H mm

2	
Handle closure casing	
Pieces per pack	📦 10

3	
Disposable security seal	
Pieces per pack	📦 500

THE LIDS ARE SUPPLIED SEPARATELY

iMilani srl reserves the right to alter the characteristics of products without notice. The values shown are nominal, with a +/- 1% tolerance for size, depending on the material, and a +/- 3% for weight.