

HANDLES

moulded closed



	H	75	120	170	220	270	320	420
200 x 150		■	■					
200 x 150		■	■					
300 x 200		■	■	■	■			
300 x 200		■	■	■	■			
400 x 300		■	■					
400 x 300		■	■	■	■	■		
600 x 400		■	■					
600 x 400		■	■	■	■			

open



	H	75	120	170	220	270	320	420
400 x 300				■	■	■	■	
400 x 300								
600 x 400				■	■	■	■	■
600 x 400						■	■	■



CARTER

1MICUBE

handles closing casing included *



	H	75	120	170	220	270	320	420
400 x 300				■	■	■	■	
400 x 300								
600 x 400				■	■	■	■	■
600 x 400						■	■	■



* supplied assembled

BOTTOMS

closed bottom



load capacity 20 kg

reinforced bottom

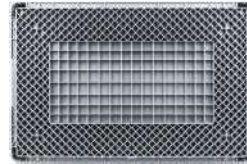

load capacity 50 kg

reinforced perforated bottom

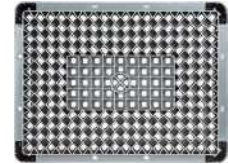

load capacity 50 kg

WALLS

closed walls



perforated walls

only for 400 x 300
and 600 x 400



available in heights:
120 - 170 - 220 - 270 - 320 - 420

picking

only for 400 x 300
and 600 x 400



available in heights:
220 - 270 - 320 - 420

ACCESSORIES

separate lid



hinged lid



snap hinged lid

only for 200 x 150
and 300 x 200



2 parts lid

only for 400 x 300
and 600 x 400



ARTICLE	WALLS		BOTTOM			HANDLES		GR.	PACKAGING		UNIT PRICE €
	Closed	Perforated	Closed	Perforated	Reinforced	Closed	Open		Qty. per pack.	Qty. per pallet	
NX 2108A 5101	■		■			■		184	32	1152	
NX 2108A 5401	■		■			■		192	32	1152	



A

Closed bottom
Load capacity 15 kg



A

Stacked edge height	60 mm
Usable stacked height / with lid	57 mm / 61 mm
Usable internal dimensions	163 x 113 x 72 H mm
Volume	1,4 L
Pieces per package / pallet	32 1152
Package dimensions	620 x 420 x 290 H mm
Pallet dimensions	1200 x 800 x 2325 H mm

DATASHEET

	ARTICLE	SEPARATE LID	HINGED LID	SNAP HINGED LID	GR.	PACKAGING		UNIT PRICE €	
						Qty. per pack.	Qty. per pallet		
1	NX 21SE 5101	■			72	1	1920		
	NX 21SE 5401	■			75	1	1920		
2	NX 21HG 5101		■		72	1	1920		
	NX 21HG 5401		■		75	1	1920		
3	NX 21HH 5101			■	73	1	1920		
	NX 21HH 5401			■	76	1	1920		
4	NX SEAL23 5113		1 x	1 x		500			



DATASHEET

Separate lid	200 x 150 mm
1 Pieces per pack.	1
Pieces per pallet / dimens.	1920 / 1200 x 800 x 942 H mm
Hinged lid	200 x 150 mm
2 Pieces per pack.	1
Pieces per pallet / dimens.	1920 / 1200 x 800 x 942 H mm
Snap hinged lid	200 x 150 mm
3 Pieces per pack.	1
Pieces per pallet / dimens.	1920 / 1200 x 800 x 942 H mm
Disposable security seal	
4 Pieces per pack	500

iMilani srl reserves the right to alter the characteristics of products without notice. The values shown are nominal, with a +/- 1% tolerance for size, depending on the material, and a +/- 3% for weight.

200 x 150 mm H 120 mm

ARTICLE	WALLS		BOTTOM			HANDLES		GR.	PACKAGING		UNIT PRICE €
	Closed	Perforated	Closed	Perforated	Reinforced	Closed	Open		Qty. per pack.	Qty. per pallet	
NX 2112A 5101	■		■			■		258	24	672	
NX 2112A 5401	■		■			■		269	24	672	

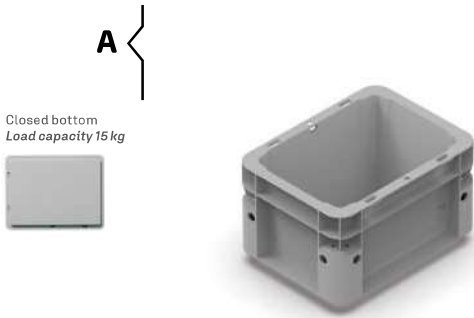

A	
Stacked edge height	105 mm
Usable stacked height / with lid	102 mm / 106 mm
Usable internal dimensions	163 x 113 x 117 H mm
Volume	2,3 L
Pieces per package / pallet	📦 24 🚚 672
Package dimensions	620 x 420 x 365 H mm
Pallet dimensions	1200 x 800 x 2370 H mm

DATASHEET

	ARTICLE	SEPARATE LID	HINGED LID	SNAP HINGED LID	GR.	PACKAGING		UNIT PRICE €	
						Qty. per pack.	Qty. per pallet		
1	NX 21SE 5101	■			72	1	1920		
	NX 21SE 5401	■			75	1	1920		
2	NX 21HG 5101		■		72	1	1920		
	NX 21HG 5401		■		75	1	1920		
3	NX 21HH 5101			■	73	1	1920		
	NX 21HH 5401			■	76	1	1920		
4	NX SEAL23 5113		1 x	1 x		500			



DATASHEET

Separate lid	200 x 150 mm
1 Pieces per pack.	1
Pieces per pallet / dimens.	1920 / 1200 x 800 x 942 H mm
Hinged lid	200 x 150 mm
2 Pieces per pack.	1
Pieces per pallet / dimens.	1920 / 1200 x 800 x 942 H mm
Snap hinged lid	200 x 150 mm
3 Pieces per pack.	1
Pieces per pallet / dimens.	1920 / 1200 x 800 x 942 H mm
Disposable security seal	
4 Pieces per pack	500

iMilani srl reserves the right to alter the characteristics of products without notice. The values shown are nominal, with a +/- 1% tolerance for size, depending on the material, and a +/- 3% for weight.

300 x 200 mm H 75 mm

ARTICLE	WALLS		BOTTOM			HANDLES		GR.	PACKAGING		UNIT PRICE €
	Closed	Perforated	Closed	Perforated	Reinforced	Closed	Open		Qty. per pack.	Qty. per pallet	
NX 3208A 5101	■		■			■		335	20	560	
NX 3208A 5401	■		■			■		350	20	560	

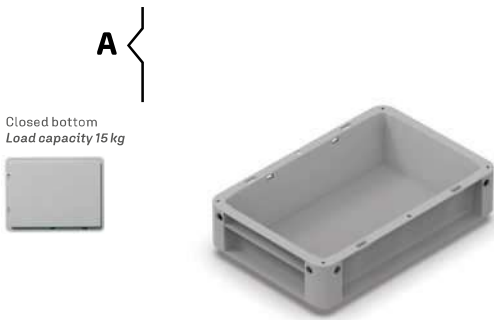

Closed bottom
Load capacity 15 kg

A

Stacked edge height	60 mm
Usable stacked height / with lid	57 mm / 61 mm
Usable internal dimensions	261 x 161 x 72 H mm
Volume	3,2 L
Pieces per package / pallet	📦 20 🚚 560
Package dimensions	620 x 420 x 350 H mm
Pallet dimensions	1200 x 800 x 2325 H mm

DATASHEET

	ARTICLE	SEPARATE LID	HINGED LID	SNAP HINGED LID	GR.	PACKAGING		UNIT PRICE €	
						Qty. per pack.	Qty. per pallet		
1	NX 32SE 5101	■			138	1	1120		
	NX 32SE 5401	■			134	1	1120		
2	NX 32HG 5101		■		136	1	1120		
	NX 32HG 5401		■		142	1	1120		
3	NX 32HH 5101			■	137	1	1120		
	NX 32HH 5401			■	143	1	1120		
4	NX SEAL23 5113		2 x	2 x		500			



1



2



3



4

DATASHEET

	Separate lid	300 x 200 mm
1	Pieces per pack.	1
	Pieces per pallet / dimens.	1120/1200x800x1072H mm
	Hinged lid	300 x 200 mm
2	Pieces per pack.	1
	Pieces per pallet / dimens.	1120/1200x800x1072H mm
	Snap hinged lid	300 x 200 mm
3	Pieces per pack.	1
	Pieces per pallet / dimens.	1120/1200x800x1072H mm
	Disposable security seal	
4	Pieces per pack	500

300 x 200 mm H 120 mm

ARTICLE	WALLS		BOTTOM			HANDLES		GR.	PACKAGING		UNIT PRICE €
	Closed	Perforated	Closed	Perforated	Reinforced	Closed	Open		Qty. per pack.	Qty. per pallet	
NX 3212A 5101	■		■			■		450	16	320	
NX 3212A 5401	■		■			■		470	16	320	

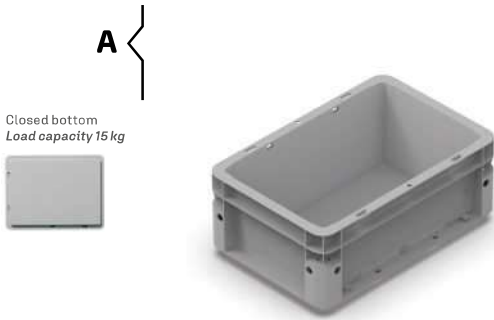

Closed bottom
Load capacity 15 kg

A

Stacked edge height	105 mm
Usable stacked height / with lid	102 mm / 106 mm
Usable internal dimensions	261 x 161 x 117 H mm
Volume	5,2 L
Pieces per package / pallet	📦 16 🚚 320
Package dimensions	620 x 420 x 470 H mm
Pallet dimensions	1200 x 800 x 2370 H mm

DATASHEET

	ARTICLE	SEPARATE LID	HINGED LID	SNAP HINGED LID	GR.	PACKAGING		UNIT PRICE €	
						Qty. per pack.	Qty. per pallet		
1	NX 32SE 5101	■			138	1	1120		♻️ PP
	NX 32SE 5401	■			134	1	1120		♻️ ECOGREEN PP
2	NX 32HG 5101		■		136	1	1120		♻️ PP
	NX 32HG 5401		■		142	1	1120		♻️ ECOGREEN PP
3	NX 32HH 5101			■	137	1	1120		♻️ PP
	NX 32HH 5401			■	143	1	1120		♻️ ECOGREEN PP
4	NX SEAL23 5113		2 x	2 x		500			♻️ PP
5	LH TYT	Label holders - for long sides only				10			♻️ PP



1



2



3



4



5

DATASHEET

Separate lid	300 x 200 mm
1 Pieces per pack.	📦 1
Pieces per pallet / dimens.	🚚 1120/1200x800x1072H mm
Hinged lid	300 x 200 mm
2 Pieces per pack.	📦 1
Pieces per pallet / dimens.	🚚 1120/1200x800x1072H mm
Snap hinged lid	300 x 200 mm
3 Pieces per pack.	📦 1
Pieces per pallet / dimens.	🚚 1120/1200x800x1072H mm
Disposable security seal	
4 Pieces per pack	📦 500
Label holders	
5 Pieces per pack	📦 10

iMilani srl reserves the right to alter the characteristics of products without notice. The values shown are nominal, with a +/- 1% tolerance for size, depending on the material, and a +/- 3% for weight.

ARTICLE	WALLS		BOTTOM			HANDLES		GR.	PACKAGING		UNIT PRICE €
	Closed	Perforated	Closed	Perforated	Reinforced	Closed	Open		Qty. per pack.	Qty. per pallet	
NX 3217A 5101	■		■			■		552	12	240	
NX 3217A 5401	■		■			■		576	12	240	









Closed bottom
Load capacity 15 kg

A

Stacked edge height	155 mm
Usable stacked height / with lid	152 mm / 156 mm
Usable internal dimensions	261 x 161 x 167 H mm
Volume	7,4 L
Pieces per package / pallet	📦 12 🚚 240
Package dimensions	620 x 420 x 515 H mm
Pallet dimensions	1200 x 800 x 2490 H mm

DATASHEET

	ARTICLE	SEPARATE LID	HINGED LID	SNAP HINGED LID	GR.	PACKAGING		UNIT PRICE €	
						Qty. per pack.	Qty. per pallet		
1	NX 32SE 5101	■			138	1	1120		
	NX 32SE 5401	■			134	1	1120		
2	NX 32HG 5101		■		136	1	1120		
	NX 32HG 5401		■		142	1	1120		
3	NX 32HH 5101			■	137	1	1120		
	NX 32HH 5401			■	143	1	1120		
4	NX SEAL23 5113		2 x	2 x		500			
5	LH TYT	Label holders - for long sides only				10			



1



2



3



4



5

DATASHEET

	Separate lid	300 x 200 mm
1	Pieces per pack.	 1
	Pieces per pallet / dimens.	 1120/1200x800x1072H mm
	Hinged lid	300 x 200 mm
2	Pieces per pack.	 1
	Pieces per pallet / dimens.	 1120/1200x800x1072H mm
	Snap hinged lid	300 x 200 mm
3	Pieces per pack.	 1
	Pieces per pallet / dimens.	 1120/1200x800x1072H mm
4	Disposable security seal	
	Pieces per pack	 500
5	Label holders	
	Pieces per pack	 10

iMilani srl reserves the right to alter the characteristics of products without notice. The values shown are nominal, with a +/- 1% tolerance for size, depending on the material, and a +/- 3% for weight.

ARTICLE	WALLS		BOTTOM			HANDLES		GR.	PACKAGING		UNIT PRICE €
	Closed	Perforated	Closed	Perforated	Reinforced	Closed	Open		Qty. per pack.	Qty. per pallet	
NX 3222A 5101	■		■			■		654	8	160	
NX 3222A 5401	■		■			■		683	8	160	

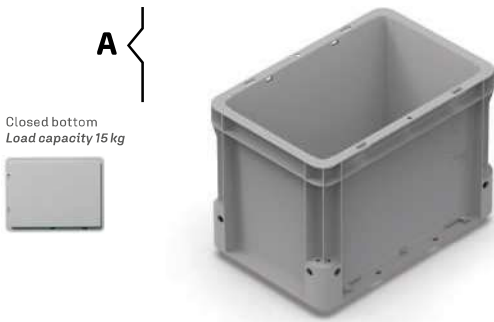

A	
Stacked edge height	205 mm
Usable stacked height / with lid	202 mm / 206 mm
Usable internal dimensions	261 x 161 x 217 H mm
Volume	9,6 L
Pieces per package / pallet	📦 8 🚚 160
Package dimensions	620 x 420 x 460 H mm
Pallet dimensions	1200 x 800 x 2215 H mm

DATASHEET

iMilani srl reserves the right to alter the characteristics of products without notice. The values shown are nominal, with a +/- 1% tolerance for size, depending on the material, and a +/- 3% for weight.

	ARTICLE	SEPARATE LID	HINGED LID	SNAP HINGED LID	GR.	PACKAGING		UNIT PRICE €	
						Qty. per pack.	Qty. per pallet		
1	NX 32SE 5101	■			138	1	1120		♻️ PP
	NX 32SE 5401	■			134	1	1120		♻️ ECOGREEN PP
2	NX 32HG 5101		■		136	1	1120		♻️ PP
	NX 32HG 5401		■		142	1	1120		♻️ ECOGREEN PP
3	NX 32HH 5101			■	137	1	1120		♻️ PP
	NX 32HH 5401			■	143	1	1120		♻️ ECOGREEN PP
4	NX SEAL23 5113		2 x	2 x		500			♻️ PP
5	LH TYT	Label holders - for long sides only				10			♻️ PP



1



2



3



4

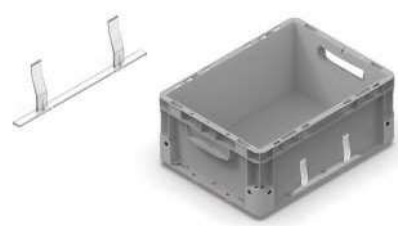

5

DATASHEET

Separate lid	300 x 200 mm
1 Pieces per pack.	📦 1
Pieces per pallet / dimens.	🚚 1120/1200x800x1072H mm
Hinged lid	300 x 200 mm
2 Pieces per pack.	📦 1
Pieces per pallet / dimens.	🚚 1120/1200x800x1072H mm
Snap hinged lid	300 x 200 mm
3 Pieces per pack.	📦 1
Pieces per pallet / dimens.	🚚 1120/1200x800x1072H mm
Disposable security seal	
4 Pieces per pack	📦 500
Label holders	
5 Pieces per pack	📦 10

iMilani srl reserves the right to alter the characteristics of products without notice. The values shown are nominal, with a +/- 1% tolerance for size, depending on the material, and a +/- 3% for weight.

	ARTICLE	WALLS		BOTTOM			HANDLES		GR.	PACKAGING		UNIT PRICE €
		Closed	Perforated	Closed	Perforated	Reinforced	Closed	Open		Qty. per pack.	Qty. per pallet	
A	NX 4308A 5101	■		■			■		595	14	280	
	NX 4308A 5401	■		■			■		621	14	280	
C	NX 4308C 5101	■				■	■		810	14	280	
	ARTICLE ON REQUEST											
C	NX 4308C 5401	■				■	■		864	14	280	



ECOGREEN



ECOGREEN

A

Closed bottom
Load capacity 20 kg



C

Reinforced bottom
Load capacity 50 kg



A

Stacked edge height	60 mm
Usable stacked height / with lid	57 mm / 61 mm
Usable internal dimensions	361 x 261 x 72 H mm
Volume	6,9 L
Pieces per package / pallet	📦 14 🚚 280
Package dimensions	620 x 420 x 470 H mm
Pallet dimensions	1200 x 800 x 2325 H mm

C

Stacked edge height	60 mm
Usable stacked height / with lid	45 mm / 49 mm
Usable internal dimensions	361 x 261 x 60 H mm
Volume	5,8 L
Pieces per package / pallet	📦 14 🚚 280
Package dimensions	620 x 420 x 470 H mm
Pallet dimensions	1200 x 800 x 2325 H mm

DATASHEET

iMilani srl reserves the right to alter the characteristics of products without notice. The values shown are nominal, with a +/- 1% tolerance for size, depending on the material, and a +/- 3% for weight.

ARTICLES ON REQUEST

Minimum order.....200 boxes
Guaranteed shipping within.....60 days

	ARTICLE	SEPARATE LID	HINGED LID	2 PARTS LID	GR.	PACKAGING		UNIT PRICE €	
						Qty. per pack.	Qty. per pallet		
1	NX 43SE 5101	■			327	1	480		♻️ PP
	NX 43SE 5401	■			341	1	480		♻️ ECOGREEN PP
2	NX 43HG 5101		■		319	1	480		♻️ PP
	NX 43HG 5401		■		333	1	480		♻️ ECOGREEN PP
3	NX 43CR 5101			■	486	1	480		♻️ PP
	NX 43CR 5401			■	508	1	480		♻️ ECOGREEN PP
4	NX SEAL46 5113			2 x		500			♻️ PP
5	AT LOCK 8113		2 x			10			♻️ PP



1



2



3



4



5

DATASHEET

Separate lid	400 x 300 mm
1 Pieces per pack.	📦 1
Pieces per pallet / dims.	📦 480 / 1200x800x870 H mm

Hinged lid	400 x 300 mm
2 Pieces per pack.	📦 1
Pieces per pallet / dims.	📦 480 / 1200x800x870 H mm

2-parts lid	400 x 300 mm
3 Pieces per pack.	📦 1
Pieces per pallet / dims.	📦 480 / 1200x800x870 H mm

Disposable security seal	
4 Pieces per pack	📦 500

Pair closing clips	
5 Pieces per pack	📦 10

iMilani srl reserves the right to alter the characteristics of products without notice. The values shown are nominal, with a +/- 1% tolerance for size, depending on the material, and a +/- 3% for weight.

	ARTICLE	WALLS		BOTTOM			HANDLES		GR.	PACKAGING		UNIT PRICE €
		Closed	Perforated	Closed	Perforated	Reinforced	Closed	Open		Qty. per pack.	Qty. per pallet	
♻️ ECOGREEN	A NX 4312A 5101	■		■			■		761	8	160	
	A NX 4312A 5401	■		■			■		794	8	160	
♻️	C NX 4312C 5101	■				■	■		976	8	160	
♻️	P NX 4312P 5101		■			■	■		914	8	160	
⚠️ ARTICLE ON REQUEST												
♻️	C NX 4312C 5401	■				■	■		1020	8	160	
♻️	P NX 4312P 5401		■			■	■		955	8	160	

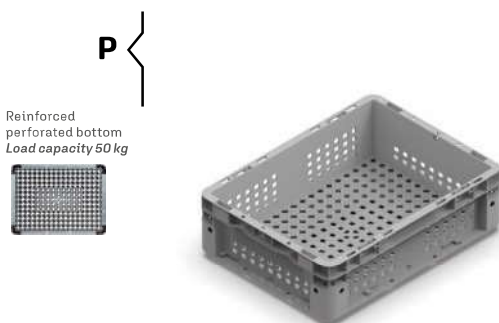
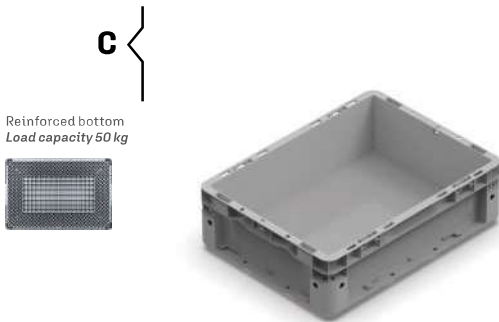
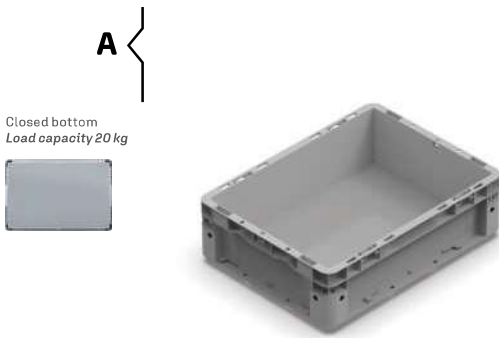

A	
Stacked edge height	105 mm
Usable stacked height / with lid	102 mm / 106 mm
Usable internal dimensions	361 x 261 x 117 H mm
Volume	11,3 L
Pieces per package / pallet	📦 8 🚚 160
Package dimensions	620 x 420 x 470 H mm
Pallet dimensions	1200 x 800 x 2370 H mm
C	
Stacked edge height	105 mm
Usable stacked height / with lid	90 mm / 94 mm
Usable internal dimensions	361 x 261 x 105 H mm
Volume	10,1 L
Pieces per package / pallet	📦 8 🚚 160
Package dimensions	620 x 420 x 470 H mm
Pallet dimensions	1200 x 800 x 2370 H mm
P	
Stacked edge height	105 mm
Usable stacked height / with lid	90 mm / 94 mm
Usable internal dimensions	361 x 261 x 105 H mm
Volume	10,1 L
Pieces per package / pallet	📦 8 🚚 160
Package dimensions	620 x 420 x 470 H mm
Pallet dimensions	1200 x 800 x 2370 H mm









DATASHEET

iMilani srl reserves the right to alter the characteristics of products without notice. The values shown are nominal, with a +/- 1% tolerance for size, depending on the material, and a +/- 3% for weight.

⚠️ ARTICLES ON REQUEST
 Minimum order.....200 boxes
 Guaranteed shipping within.....60 days

400 x 300 mm

iMICUBE

	ARTICLE	SEPARATE LID	HINGED LID	2 PARTS LID	GR.	PACKAGING		UNIT PRICE €	
						Qty. per pack.	Qty. per pallet		
1	NX 43SE 5101	■			327	1	480		 
	NX 43SE 5401	■			341	1	480		
2	NX 43HG 5101		■		319	1	480	 	
	NX 43HG 5401		■		333	1	480		
3	NX 43CR 5101			■	486	1	480	 	
	NX 43CR 5401			■	508	1	480		
4	NX SEAL46 5113			2 x		500		  	
5	AT LOCK 8113		2 x			10			
6	LH TYT	Label holders for all sides					10		



1



2



3



4



5



6

DATASHEET

	Separate lid	400 x 300 mm
1	Pieces per pack.	📦 1
	Pieces per pallet / dims.	📦 480 / 1200x800x870 H mm
	Hinged lid	400 x 300 mm
2	Pieces per pack.	📦 1
	Pieces per pallet / dims.	📦 480 / 1200x800x870 H mm
	2-parts lid	400 x 300 mm
3	Pieces per pack.	📦 1
	Pieces per pallet / dims.	📦 480 / 1200x800x870 H mm
	Disposable security seal	
4	Pieces per pack	📦 10
	Pair closing clips	
5	Pieces per pack	📦 500
	Label holders	
6	Pieces per pack	📦 10

iMilani srl reserves the right to alter the characteristics of products without notice. The values shown are nominal, with a +/- 1% tolerance for size, depending on the material, and a +/- 3% for weight.

	ARTICLE	WALLS		BOTTOM			HANDLES		GR.	PACKAGING		UNIT PRICE €
		Closed	Perforated	Closed	Perforated	Reinforced	Closed	Open		Qty. per pack.	Qty. per pallet	
	B NX 4317B 5101	■		■			■		899	6	120	
	A NX 4317A 5401	■		■			■		939	6	120	
	D NX 4317D 5101	■				■		■	1115	6	120	
	S NX 4317S 5101	■			■	■		■	1034	6	120	
	ARTICLE ON REQUEST											
	C NX 4317C 5401	■				■	■		1165	6	120	
	P NX 4317P 5401		■			■	■		1081	6	120	

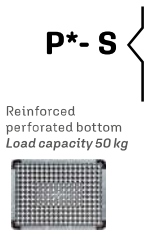
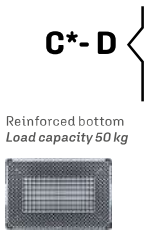
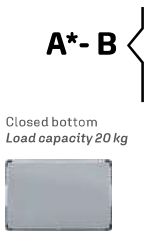

* **ECOGREEN** with closed moulded handle

iMilani srl reserves the right to alter the characteristics of products without notice. The values shown are nominal, with a +/- 1% tolerance for size, depending on the material, and a +/- 3% for weight.

A - B

Stacked edge height	155 mm
Usable stacked height / with lid	152 mm / 156 mm
Usable internal dimensions	361 x 261 x 167 H mm
Volume	16,1 L
Pieces per package / pallet	6 120
Package dimensions	620 x 420 x 515 H mm
Pallet dimensions	1200 x 800 x 2490 H mm

C - D

Stacked edge height	155 mm
Usable stacked height / with lid	140 mm / 144 mm
Usable internal dimensions	361 x 261 x 155 H mm
Volume	15 L
Pieces per package / pallet	6 120
Package dimensions	620 x 420 x 515 H mm
Pallet dimensions	1200 x 800 x 2490 H mm

P - S











Stacked edge height	155 mm
Usable stacked height / with lid	140 mm / 144 mm
Usable internal dimensions	361 x 261 x 155 H mm
Volume	15 L
Pieces per package / pallet	6 120
Package dimensions	620 x 420 x 515 H mm
Pallet dimensions	1200 x 800 x 2490 H mm

ARTICLES ON REQUEST

Minimum order.....200 boxes
Guaranteed shipping within.....60 days

400 x 300 mm

iMICUBE

	ARTICLE	SEPARATE LID	HINGED LID	2 PARTS LID	GR.	PACKAGING		UNIT PRICE €	
						Qty. per pack.	Qty. per pallet		
1	NX 43SE 5101	■				327	1 480		 
	NX 43SE 5401	■				341	1 480		
2	NX 43HG 5101		■			319	1 480		 
	NX 43HG 5401		■			333	1 480		
3	NX 43CR 5101			■		486	1 480		 
	NX 43CR 5401			■		508	1 480		
4	NX SEAL46 5113			2 x			500		 
5	AT LOCK 8113		2 x				10		 
6	LH TYT	Label holders for all sides					10		



1



2



3



4



5







6

DATASHEET



	Separate lid	400 x 300 mm
1	Pieces per pack.	📦 1
	Pieces per pallet / dims.	📦 480 / 1200x800x870 H mm
	Hinged lid	400 x 300 mm
2	Pieces per pack.	📦 1
	Pieces per pallet / dims.	📦 480 / 1200x800x870 H mm
	2-parts lid	400 x 300 mm
3	Pieces per pack.	📦 1
	Pieces per pallet / dims.	📦 480 / 1200x800x870 H mm
	Disposable security seal	
4	Pieces per pack	📦 10
	Pair closing clips	
5	Pieces per pack	📦 500
	Label holders	
6	Pieces per pack	📦 10

iMilani srl reserves the right to alter the characteristics of products without notice. The values shown are nominal, with a +/- 1% tolerance for size, depending on the material, and a +/- 3% for weight.

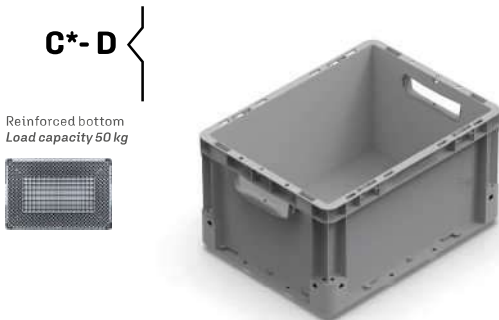
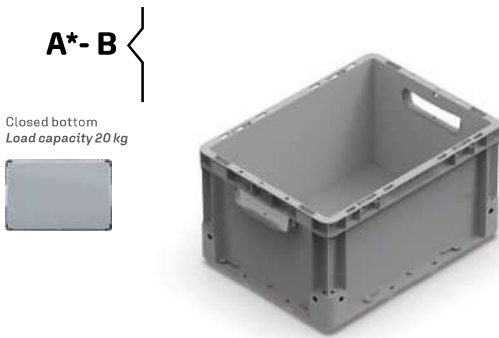

	ARTICLE	WALLS		BOTTOM			HANDLES		GR.	PACKAGING		UNIT PRICE €
		Closed	Perforated	Closed	Perforated	Reinforced	Closed	Open		Qty. per pack.	Qty. per pallet	
	B NX 4322B 5101	■		■			■		1146	4	80	
	A NX 4322A 5401	■		■			■		1198	4	80	
	D NX 4322D 5101	■				■	■		1257	4	80	
	ARTICLE ON REQUEST											
	C NX 4322C 5401	■				■	■		1314	4	80	



A - B

Stacked edge height	205 mm
Usable stacked height / with lid	202 mm / 206 mm
Usable internal dimensions	361 x 261 x 217 H mm
Volume	20,9 L
Pieces per package / pallet	 4  80
Package dimensions	620 x 420 x 460 H mm
Pallet dimensions	1200 x 800 x 2215 H mm

C - D

Stacked edge height	205 mm
Usable stacked height / with lid	190 mm / 194 mm
Usable internal dimensions	361 x 261 x 205 H mm
Volume	19,8 L
Pieces per package / pallet	 4  80
Package dimensions	620 x 420 x 460 H mm
Pallet dimensions	1200 x 800 x 2215 H mm

DATASHEET

* **ECOGREEN** with closed moulded handle

CONTINUED ON NEXT PAGE













iMilani srl reserves the right to alter the characteristics of products without notice. The values shown are nominal, with a +/- 1% tolerance for size, depending on the material, and a +/- 3% for weight.

 **ARTICLES ON REQUEST**

Minimum order.....200 boxes
Guaranteed shipping within.....60 days

400 x 300 mm

iMICUBE

	ARTICLE	SEPARATE LID	HINGED LID	2 PARTS LID	GR.	PACKAGING		UNIT PRICE €	
						Qty. per pack.	Qty. per pallet		
1	NX 43SE 5101	■				327	1 480		 
	NX 43SE 5401	■				341	1 480		
2	NX 43HG 5101		■			319	1 480	 	
	NX 43HG 5401		■			333	1 480		
3	NX 43CR 5101			■		486	1 480	 	
	NX 43CR 5401			■		508	1 480		
4	NX SEAL46 5113			2 x			500	 	
5	AT LOCK 8113		2 x				10	 	
6	LH TYT	Label holders for all sides					10		



1



2



3



4



5



6

DATASHEET

	Separate lid	400 x 300 mm
1	Pieces per pack.	1
	Pieces per pallet / dims.	480 / 1200x800x870 H mm
	Hinged lid	400 x 300 mm
2	Pieces per pack.	1
	Pieces per pallet / dims.	480 / 1200x800x870 H mm
	2-parts lid	400 x 300 mm
3	Pieces per pack.	1
	Pieces per pallet / dims.	480 / 1200x800x870 H mm
4	Disposable security seal	
	Pieces per pack	10
5	Pair closing clips	
	Pieces per pack	500
6	Label holders	
	Pieces per pack	10

iMilani srl reserves the right to alter the characteristics of products without notice. The values shown are nominal, with a +/- 1% tolerance for size, depending on the material, and a +/- 3% for weight.

	ARTICLE	WALLS			BOTTOM			HANDLES		GR.	PACKAGING		UNIT PRICE €
		Closed	Perforated	Picking short side	Closed	Perforated	Reinforced	Closed	Open		Qty. per pack.	Qty. per pallet	
	S NX 4322S 5101	■				■	■		■	1153	4	80	
	U NX 4322U 5101			■	■				■	1080	4	80	
	ARTICLE ON REQUEST												
	P NX 4322P 5401	■				■	■	■		1205	4	80	
	V NX 4322V 5401			■	■			■		1129	4	80	

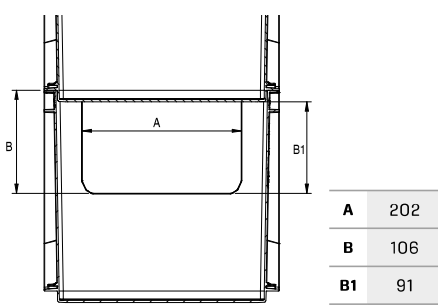
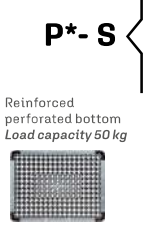

* **ECOGREEN** with closed moulded handle

◀ CONTINUED ON PREVIOUS PAGE

iMilani srl reserves the right to alter the characteristics of products without notice. The values shown are nominal, with a +/- 1% tolerance for size, depending on the material, and a +/- 3% for weight.

P - S

Stacked edge height	205 mm
Usable stacked height / with lid	190 mm / 194 mm
Usable internal dimensions	361 x 261 x 205 H mm
Volume	19,8 L
Pieces per package / pallet	4 80
Package dimensions	620 x 420 x 460 H mm
Pallet dimensions	1200 x 800 x 2215 H mm

V - U

Stacked edge height	205 mm
Usable stacked height / with lid	202 mm / 206 mm
Usable internal dimensions	361 x 261 x 217 H mm
Volume	20,9 L
Pieces per package / pallet	4 80
Package dimensions	620 x 420 x 460 H mm
Pallet dimensions	1200 x 800 x 2215 H mm











DATASHEET

ARTICLES ON REQUEST

Minimum order.....200 boxes
Guaranteed shipping within.....60 days

400 x 300 mm

iMICUBE

	ARTICLE	SEPARATE LID	HINGED LID	2 PARTS LID	GR.	PACKAGING		UNIT PRICE €	
						Qty. per pack.	Qty. per pallet		
1	NX 43SE 5101	■			327	1	480		
	NX 43SE 5401	■			341	1	480		
2	NX 43HG 5101		■		319	1	480		
	NX 43HG 5401		■		333	1	480		
3	NX 43CR 5101			■	486	1	480		
	NX 43CR 5401			■	508	1	480		
4	NX SEAL46 5113			2 x		500			
5	AT LOCK 8113		2 x			10			
6	LH TYT	Label holders for all sides				10			
7	NX WC43326896	H220 Door				1			



1



2



3



4



5













6



7

DATASHEET

Separate lid	400 x 300 mm
1 Pieces per pack.	 1
Pieces per pallet / dims.	 480 / 1200x800x870 H mm
Hinged lid	400 x 300 mm
2 Pieces per pack.	 1
Pieces per pallet / dims.	 480 / 1200x800x870 H mm
2-parts lid	400 x 300 mm
3 Pieces per pack.	 1
Pieces per pallet / dims.	 480 / 1200x800x870 H mm
Disposable security seal	
4 Pieces per pack	 500
Pair closing clips	
5 Pieces per pack	 10
Label holders	
6 Pieces per pack	 10
H220 Door	
7 Pieces per pack	 1

iMilani srl reserves the right to alter the characteristics of products without notice. The values shown are nominal, with a +/- 1% tolerance for size, depending on the material, and a +/- 3% for weight.

	ARTICLE	WALLS		BOTTOM			HANDLES		GR.	PACKAGING		UNIT PRICE €
		Closed	Perforated	Closed	Perforated	Reinforced	Closed	Open		Qty. per pack.	Qty. per pallet	
	B NX 4327B 5101	■		■			■		1186	4	64	
	A NX 4327A 5401	■		■			■		1239	4	64	
	D NX 4327D 5101	■				■		■	1401	4	64	
	ARTICLE ON REQUEST											
	C NX 4327C 5401	■				■	■		1463	4	64	

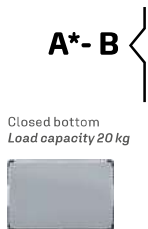

A - B

Stacked edge height	255 mm
Usable stacked height / with lid	252 mm / 256 mm
Usable internal dimensions	361 x 261 x 267 H mm
Volume	25,8 L
Pieces per package / pallet	4 64
Package dimensions	620 x 420 x 560 H mm
Pallet dimensions	1200 x 800 x 2205 H mm

C - D

Stacked edge height	255 mm
Usable stacked height / with lid	240 mm / 244 mm
Usable internal dimensions	361 x 261 x 255 H mm
Volume	24,6 L
Pieces per package / pallet	4 64
Package dimensions	620 x 420 x 560 H mm
Pallet dimensions	1200 x 800 x 2205 H mm

DATASHEET

* **ECOGREEN** with closed moulded handle

CONTINUED ON NEXT PAGE













iMilani srl reserves the right to alter the characteristics of products without notice. The values shown are nominal, with a +/- 1% tolerance for size, depending on the material, and a +/- 3% for weight.

ARTICLES ON REQUEST

Minimum order.....200 boxes
Guaranteed shipping within.....60 days

400 x 300 mm

iMICUBE

	ARTICLE	SEPARATE LID	HINGED LID	2 PARTS LID	GR.	PACKAGING		UNIT PRICE €	
						Qty. per pack.	Qty. per pallet		
1	NX 43SE 5101	■			327	1	480		 
	NX 43SE 5401	■			341	1	480		
2	NX 43HG 5101		■		319	1	480		 
	NX 43HG 5401		■		333	1	480		
3	NX 43CR 5101			■	486	1	480		 
	NX 43CR 5401			■	508	1	480		
4	NX SEAL46 5113			2 x		500			 
5	AT LOCK 8113		2 x			10			 
6	LH TYT	Label holders for all sides				10			



1



2



3



4



5



6

DATASHEET

	Separate lid	400 x 300 mm
1	Pieces per pack.	📦 1
	Pieces per pallet / dims.	📦 480 / 1200x800x870 H mm
	Hinged lid	400 x 300 mm
2	Pieces per pack.	📦 1
	Pieces per pallet / dims.	📦 480 / 1200x800x870 H mm
	2-parts lid	400 x 300 mm
3	Pieces per pack.	📦 1
	Pieces per pallet / dims.	📦 480 / 1200x800x870 H mm
	Disposable security seal	
4	Pieces per pack	📦 10
	Pair closing clips	
5	Pieces per pack	📦 500
	Label holders	
6	Pieces per pack	📦 10

iMilani srl reserves the right to alter the characteristics of products without notice. The values shown are nominal, with a +/- 1% tolerance for size, depending on the material, and a +/- 3% for weight.

	ARTICLE	WALLS			BOTTOM			HANDLES		GR.	PACKAGING		UNIT PRICE €
		Closed	Perforated	Picking short side	Closed	Perforated	Reinforced	Closed	Open		Qty. per pack.	Qty. per pallet	
	S NX 4327S 5101	■				■	■		■	1271	4	64	
	U NX 4327U 5101			■	■				■	1144	4	64	
	ARTICLE ON REQUEST												
	P NX 4327P 5401	■				■	■	■		1328	4	64	
	V NX 4327V 5401			■	■			■		1195	4	64	

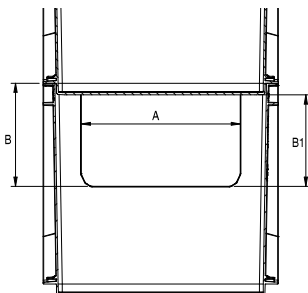
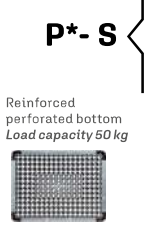

A	202
B	131
B1	116

* **ECOGREEN** with closed moulded handle

◀◀ CONTINUED ON PREVIOUS PAGE

iMilani srl reserves the right to alter the characteristics of products without notice. The values shown are nominal, with a +/- 1% tolerance for size, depending on the material, and a +/- 3% for weight.

P-S

Stacked edge height	255 mm
Usable stacked height / with lid	240 mm / 244 mm
Usable internal dimensions	361 x 261 x 255 H mm
Volume	25,8 L
Pieces per package / pallet	4 64
Package dimensions	620 x 420 x 560 H mm
Pallet dimensions	1200 x 800 x 2205 H mm

V-U

Stacked edge height	255 mm
Usable stacked height / with lid	252 mm / 256 mm
Usable internal dimensions	361 x 261 x 267 H mm
Volume	24,6 L
Pieces per package / pallet	4 64
Package dimensions	620 x 420 x 560 H mm
Pallet dimensions	1200 x 800 x 2205 H mm











DATASHEET

ARTICLES ON REQUEST

Minimum order.....200 boxes
Guaranteed shipping within.....60 days

400 x 300 mm

iMICUBE

	ARTICLE	SEPARATE LID	HINGED LID	2 PARTS LID	GR.	PACKAGING		UNIT PRICE €	
						Qty. per pack.	Qty. per pallet		
1	NX 43SE 5101	■			327	1	480		 
	NX 43SE 5401	■			341	1	480		
2	NX 43HG 5101		■		319	1	480		 
	NX 43HG 5401		■		333	1	480		
3	NX 43CR 5101			■	486	1	480		 
	NX 43CR 5401			■	508	1	480		
4	NX SEAL46 5113			2 x		500			   
5	AT LOCK 8113		2 x			10			
6	LH TYT	Label holders for all sides					10		
7	NX WC43326896	H270 Door					1		



1



2



3



4



5



6



7

DATASHEET

Separate lid	400 x 300 mm
1 Pieces per pack.	📦 1
Pieces per pallet / dims.	🚚 480 / 1200x800x870 H mm
Hinged lid	400 x 300 mm
2 Pieces per pack.	📦 1
Pieces per pallet / dims.	🚚 480 / 1200x800x870 H mm
2-parts lid	400 x 300 mm
3 Pieces per pack.	📦 1
Pieces per pallet / dims.	🚚 480 / 1200x800x870 H mm
Disposable security seal	
4 Pieces per pack	📦 500
Pair closing clips	
5 Pieces per pack	📦 10
Label holders	
6 Pieces per pack	📦 10
H270 Door	
7 Pieces per pack	📦 1

iMilani srl reserves the right to alter the characteristics of products without notice. The values shown are nominal, with a +/- 1% tolerance for size, depending on the material, and a +/- 3% for weight.

	ARTICLE	WALLS		BOTTOM			HANDLES		GR.	PACKAGING		UNIT PRICE €
		Closed	Perforated	Closed	Perforated	Reinforced	Closed	Open		Qty. per pack.	Qty. per pallet	
	B NX 4332B 5101	■		■			■		1362	2	56	
	A NX 4332A 5401	■		■			■		1423	2	56	
	D NX 4332D 5101	■				■	■		1577	2	56	
	ARTICLE ON REQUEST											
	C NX 4332C 5401	■				■	■		1648	2	56	

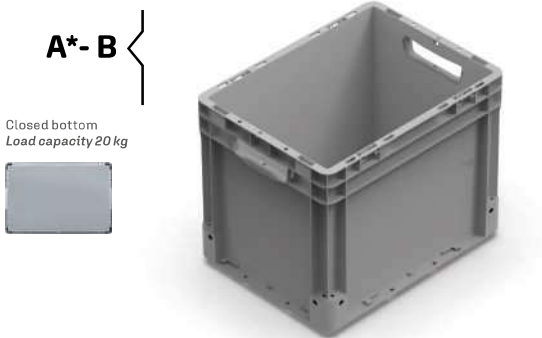

A - B	
Stacked edge height	305 mm
Usable stacked height / with lid	302 mm / 306 mm
Usable internal dimensions	361 x 261 x 317 H mm
Volume	30,6 L
Pieces per package / pallet	2 56
Package dimensions	620 x 420 x 355 H mm
Pallet dimensions	1200 x 800 x 2300 H mm
C - D	
Stacked edge height	305 mm
Usable stacked height / with lid	290 mm / 294 mm
Usable internal dimensions	361 x 261 x 305 H mm
Volume	29,5 L
Pieces per package / pallet	2 56
Package dimensions	620 x 420 x 355 H mm
Pallet dimensions	1200 x 800 x 2300 H mm

DATASHEET

* **ECOGREEN** with closed moulded handle

CONTINUED ON NEXT PAGE













iMilani srl reserves the right to alter the characteristics of products without notice. The values shown are nominal, with a +/- 1% tolerance for size, depending on the material, and a +/- 3% for weight.

ARTICLES ON REQUEST

Minimum order.....200 boxes
Guaranteed shipping within.....60 days

400 x 300 mm

iMICUBE

	ARTICLE	SEPARATE LID	HINGED LID	2 PARTS LID	GR.	PACKAGING		UNIT PRICE €	
						Qty. per pack.	Qty. per pallet		
1	NX 43SE 5101	■				327	1 480		 
	NX 43SE 5401	■				341	1 480		
2	NX 43HG 5101		■			319	1 480	 	
	NX 43HG 5401		■			333	1 480		
3	NX 43CR 5101			■		486	1 480	 	
	NX 43CR 5401			■		508	1 480		
4	NX SEAL46 5113			2 x			500	 	
5	AT LOCK 8113		2 x				10	 	
6	LH TYT	Label holders for all sides					10		



1



2



3



4



5



6

DATASHEET

	Separate lid	400 x 300 mm
1	Pieces per pack.	1
	Pieces per pallet / dims.	480 / 1200x800x870 H mm
	Hinged lid	400 x 300 mm
2	Pieces per pack.	1
	Pieces per pallet / dims.	480 / 1200x800x870 H mm
	2-parts lid	400 x 300 mm
3	Pieces per pack.	1
	Pieces per pallet / dims.	480 / 1200x800x870 H mm
4	Disposable security seal	
	Pieces per pack	10
5	Pair closing clips	
	Pieces per pack	500
6	Label holders	
	Pieces per pack	10

iMilani srl reserves the right to alter the characteristics of products without notice. The values shown are nominal, with a +/- 1% tolerance for size, depending on the material, and a +/- 3% for weight.

	ARTICLE	WALLS			BOTTOM			HANDLES		GR.	PACKAGING		UNIT PRICE €
		Closed	Perforated	Picking short side	Closed	Perforated	Reinforced	Closed	Open		Qty. per pack.	Qty. per pallet	
	S NX 4332S 5101	■				■	■	■		1434	2	56	
	U NX 4332U 5101			■	■				■	1307	2	56	
	ARTICLE ON REQUEST												
	P NX 4332P 5401	■				■	■	■		1499	2	56	
	V NX 4332V 5401			■	■			■		1366	2	56	

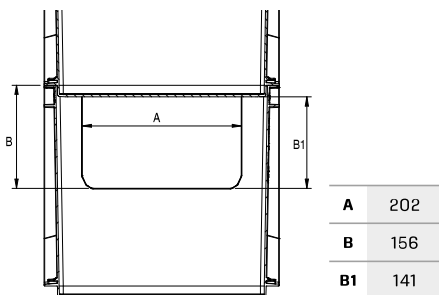
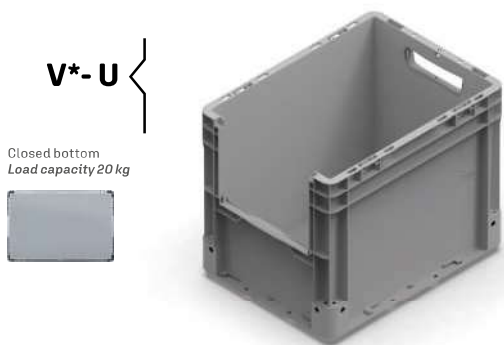
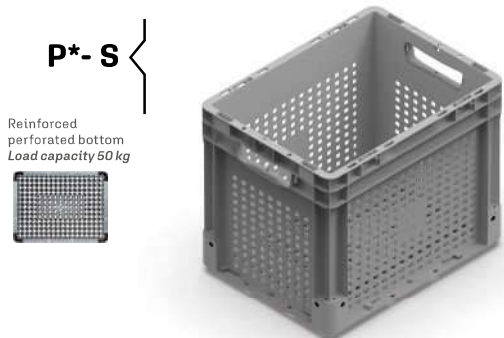

* **ECOGREEN** with closed moulded handle

◀◀ CONTINUED ON PREVIOUS PAGE

iMilani srl reserves the right to alter the characteristics of products without notice. The values shown are nominal, with a +/- 1% tolerance for size, depending on the material, and a +/- 3% for weight.

P - S

Stacked edge height	305 mm
Usable stacked height / with lid	290 mm / 294 mm
Usable internal dimensions	361 x 261 x 305 H mm
Volume	29,5 L
Pieces per package / pallet	2 56
Package dimensions	620 x 420 x 355 H mm
Pallet dimensions	1200 x 800 x 2300 H mm

V - U

Stacked edge height	305 mm
Usable stacked height / with lid	302 mm / 306 mm
Usable internal dimensions	361 x 261 x 317 H mm
Volume	30,6 L
Pieces per package / pallet	2 56
Package dimensions	620 x 420 x 355 H mm
Pallet dimensions	1200 x 800 x 2300 H mm







DATASHEET

ARTICLES ON REQUEST

Minimum order.....200 boxes
Guaranteed shipping within.....60 days

400 x 300 mm

iMICUBE

	ARTICLE	SEPARATE LID	HINGED LID	2 PARTS LID	GR.	PACKAGING		UNIT PRICE €	
						Qty. per pack.	Qty. per pallet		
1	NX 43SE 5101	■			327	1	480		
	NX 43SE 5401	■			341	1	480	ECOGREEN ✓	
2	NX 43HG 5101		■		319	1	480		
	NX 43HG 5401		■		333	1	480	ECOGREEN ✓	
3	NX 43CR 5101			■	486	1	480		
	NX 43CR 5401			■	508	1	480	ECOGREEN ✓	
4	NX SEAL46 5113			2 x		500			
5	AT LOCK 8113		2 x			10			
6	LH TYT	Label holders for all sides				10			
7	NX WC43326896	H320 Door				1			



1



2



3



4



5



6



7

DATASHEET

	Separate lid	400 x 300 mm
1	Pieces per pack.	1
	Pieces per pallet / dims.	480 / 1200x800x870 H mm
	Hinged lid	400 x 300 mm
2	Pieces per pack.	1
	Pieces per pallet / dims.	480 / 1200x800x870 H mm
	2-parts lid	400 x 300 mm
3	Pieces per pack.	1
	Pieces per pallet / dims.	480 / 1200x800x870 H mm
4	Disposable security seal	
	Pieces per pack	500
5	Pair closing clips	
	Pieces per pack	10
6	Label holders	
	Pieces per pack	10
7	H320 Door	
	Pieces per pack	1

iMilani srl reserves the right to alter the characteristics of products without notice. The values shown are nominal, with a +/- 1% tolerance for size, depending on the material, and a +/- 3% for weight.

ARTICLE	1 PARTITION	2 PARTITIONS	4 PARTITIONS	GR.	PACKAGING		UNIT PRICE €
					Qty. per pack.	Qty. per pallet	
1 AT 43S1 5407	■			230	20	320	
2 AT 43S2 5407		■		246	20	320	
3 AT 43S4 5407			■	272	20	320	
4 AT LID4 6896	Transparent lid			118	20		

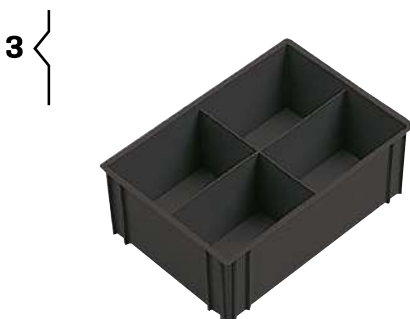

Subdivision with 1 and 2 compartments



Subdivision with 1 and 4 compartments



Subdivision with 2 and 4 compartments

1	
Partitioned box 1 partition	256 x 178 x 90 H mm
Pieces per pack / pallet	📦 20 🚚 320
Package dimensions	565 x 375 x 460 H mm
Pallet dimensions	1200 x 800 x 1990 H mm
2	
Partitioned box 2 partitions	256 x 178 x 90 H mm
Pieces per pack / pallet	📦 20 🚚 320
Package dimensions	565 x 375 x 460 H mm
Pallet dimensions	1200 x 800 x 1990 H mm
3	
Partitioned box 4 partitions	256 x 178 x 90 H mm
Pieces per pack / pallet	📦 20 🚚 320
Package dimensions	565 x 375 x 460 H mm
Pallet dimensions	1200 x 800 x 1990 H mm
4	
Transparent polystyrene lid	
Pieces per pack	📦 20
Package dimensions	265 x 195 x 180 H mm

400 x 300 mm

	ARTICLE	H 45	H 70	H 90	H 120	H 180	H 220	PACKAGING		UNIT PRICE €
								Qty. per pack.	Qty. per pallet	
1	DI 25545246801	■						10		
	DI 35545246801	■						10		
2	DI 25570246801		■					10		
	DI 35570246801		■					10		
3	DI 25590246801			■				10		
	DI 35590246801			■				10		
4	DI 25512246801				■			10		
	DI 35512246801				■			10		
5	DI 25518246801					■		10		
	DI 35518246801					■		10		
6	DI 25522246801						■	10		
	DI 35522246801						■	10		
7	DI 43SHT 5101							10		

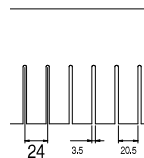

6801
Pitch 24 mm

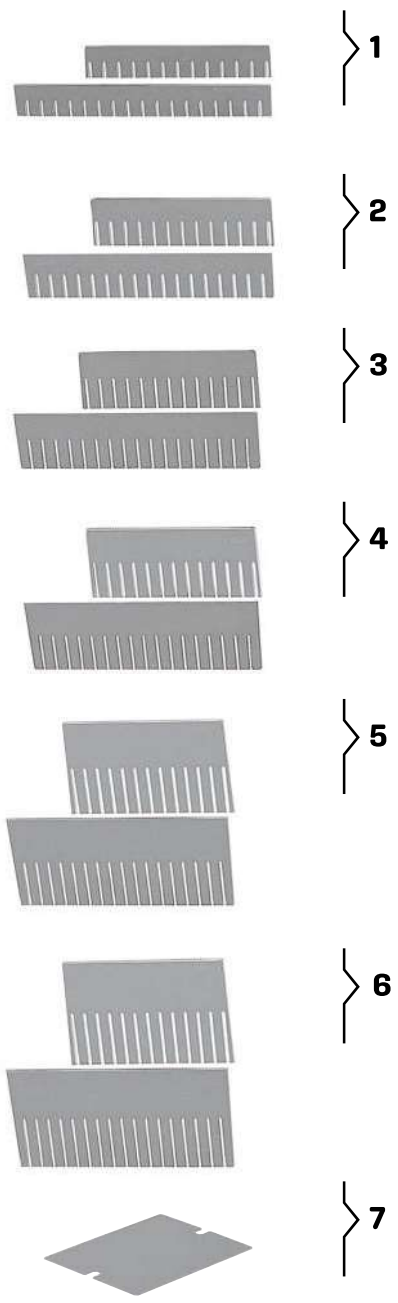

DATASHEET

1	Comb divider 255 x 45 H mm per box 400 x 300 x 75 H mm	10 items
	Séparateur type peigne 355 x H 45 mm per box 400 x 300 x H 75 mm	10 items
2	Comb divider 255 x 70 H mm per box 400 x 300 x 120 H mm	10 items
	Comb divider 355 x 70 H mm per box 400 x 300 x 120 H mm	10 items
3	Comb divider 255 x 90 H mm per box 400 x 300 x 120 H mm	10 items
	Comb divider 355 x 90 H mm per box 400 x 300 x 120 H mm	10 items
4	Comb divider 255 x 120 H mm per box 400 x 300 x 170 H mm	10 items
	Comb divider 355 x 120 H mm per box 400 x 300 x 170 H mm	10 items
5	Comb divider 255 x 180 H mm per box 400 x 300 x 220 H mm	10 items
	Comb divider 355 x 180 H mm per box 400 x 300 x 220 H mm	10 items
6	Comb divider 255 x 220 H mm per box 400 x 300 x 270 H mm	10 items
	Comb divider 355 x 220 H mm per box 400 x 300 x 270 H mm	10 items
7	Intermediate partition shelf 355 x 255 mm	10 items

600 x 400 mm H 75 mm

	ARTICLE	WALLS		BOTTOM			HANDLES		GR.	PACKAGING		UNIT PRICE €
		Closed	Perforated	Closed	Perforated	Reinforced	Closed	Open		Qty. per pack.	Qty. per pallet	
♻️ ECOGREEN	A NX 6408A5101	■		■			■		1178	7	140	
	A NX 6408A5401	■		■			■		1231	7	140	
♻️	C NX 6408C5101	■				■	■		1699	7	140	
♻️	P NX 6408P5101		■			■	■		1604	7	140	
⚠️ ARTICLE ON REQUEST												
♻️	C NX 6408C5401	■				■	■		1775	7	140	
♻️	P NX 6408P5401		■			■	■		1676	7	140	

A

Closed bottom
Load capacity 20 kg



C

Reinforced bottom
Load capacity 50 kg



P

Reinforced perforated bottom
Load capacity 50 kg



A

Stacked edge height	60 mm
Usable stacked height / with lid	57 mm / 61 mm
Usable internal dimensions	561 x 361 x 72 H mm
Volume	14,7 L
Pieces per package / pallet	📦 7 🚚 140
Package dimensions	620 x 420 x 470 H mm
Pallet dimensions	1200 x 800 x 2325 H mm

C

Stacked edge height	60 mm
Usable stacked height / with lid	45 mm / 49 mm
Usable internal dimensions	561 x 361 x 60 H mm
Volume	11,8 L
Pieces per package / pallet	📦 7 🚚 140
Package dimensions	620 x 420 x 470 H mm
Pallet dimensions	1200 x 800 x 2325 H mm







P

Stacked edge height	60 mm
Usable stacked height / with lid	45 mm / 49 mm
Usable internal dimensions	561 x 361 x 60 H mm
Volume	11,8 L
Pieces per package / pallet	📦 7 🚚 140
Package dimensions	620 x 420 x 470 H mm
Pallet dimensions	1200 x 800 x 2325 H mm

DATASHEET

iMilani srl reserves the right to alter the characteristics of products without notice. The values shown are nominal, with a +/- 1% tolerance for size, depending on the material, and a +/- 3% for weight.

⚠️ ARTICLES ON REQUEST
 Minimum order.....200 boxes
 Guaranteed shipping within.....60 days

	ARTICLE	SEPARATE LID	HINGED LID	2 PARTS LID	GR.	PACKAGING		UNIT PRICE €	
						Qty. per pack.	Qty. per pallet		
1	NX 64SE 5101	■			751	1	176		
	NX 64SE 5401	■			785	1	176	ECOGREEN ✓	
2	NX 64HG 5101		■		710	1	176		
	NX 64HG 5401		■		742	1	176	ECOGREEN ✓	
3	NX 64CR 5101			■	1016	1	176		
	NX 64CR 5401			■	1062	1	176	ECOGREEN ✓	
4	NX 64CV 5101	Cover			845	1	176		
	NX 64CV 5401	Cover			883	1	176	ECOGREEN ✓	
5	NX SEAL46 5113			2 x		500			
6	AT LOCK 8113		2 x			10			



1



2



3



4









5



6

DATASHEET

Separate lid	600 x 400 mm
1 Pieces per pack.	 1
Pieces per pallet / dimens.	 176 / 1200 x 800 x 870 H mm
Hinged lid	600 x 400 mm
2 Pieces per pack.	 1
Pieces per pallet / dimens.	 176 / 1200 x 800 x 870 H mm
2-parts lid	600 x 400 mm
3 Pieces per pack.	 1
Pieces per pallet / dimens.	 176 / 1200 x 800 x 870 H mm
Cover	600 x 400 mm
4 Pieces per pack.	 1
Pieces per pallet / dimens.	 176 / 1200 x 800 x 870 H mm
Disposable security seal	
5 Pieces per pack	 500
Pair closing clips	
6 Pieces per pack	 10

	ARTICLE	WALLS		BOTTOM			HANDLES		GR.	PACKAGING		UNIT PRICE €
		Closed	Perforated	Closed	Perforated	Reinforced	Closed	Open		Qty. per pack.	Qty. per pallet	
♻️ ECOGREEN	A NX 6412A 5101	■		■			■		1441	4	80	
	A NX 6412A 5401	■		■			■		1506	4	80	
♻️	C NX 6412C 5101	■				■	■		1961	4	80	
♻️	P NX 6412P 5101		■		■	■	■		1828	4	80	
⚠️ ARTICLE ON REQUEST												
♻️	C NX 6412C 5401	■				■	■		2049	4	80	
♻️	P NX 6412P 5401		■		■	■	■		1910	4	80	

A

Closed bottom
Load capacity 20 kg



C

Reinforced bottom
Load capacity 50 kg



P

Reinforced perforated bottom
Load capacity 50 kg



A	
Stacked edge height	105 mm
Usable stacked height / with lid	102 mm / 106 mm
Usable internal dimensions	561 x 361 x 117 H mm
Volume	23,9 L
Pieces per package / pallet	📦 4 🚚 80
Package dimensions	620 x 420 x 470 H mm
Pallet dimensions	1200 x 800 x 2370 H mm
C	
Stacked edge height	105 mm
Usable stacked height / with lid	90 mm / 94 mm
Usable internal dimensions	561 x 361 x 105 H mm
Volume	21,1 L
Pieces per package / pallet	📦 4 🚚 80
Package dimensions	620 x 420 x 470 H mm
Pallet dimensions	1200 x 800 x 2370 H mm
P	
Stacked edge height	105 mm
Usable stacked height / with lid	90 mm / 94 mm
Usable internal dimensions	561 x 361 x 105 H mm
Volume	21,1 L
Pieces per package / pallet	📦 4 🚚 80
Package dimensions	620 x 420 x 470 H mm
Pallet dimensions	1200 x 800 x 2370 H mm







DATASHEET

iMilani srl reserves the right to alter the characteristics of products without notice. The values shown are nominal, with a +/- 1% tolerance for size, depending on the material, and a +/- 3% for weight.

⚠️ ARTICLES ON REQUEST
 Minimum order.....200 boxes
 Guaranteed shipping within.....60 days

600 x 400 mm

iMICUBE

	ARTICLE	SEPARATE LID	HINGED LID	2 PARTS LID	GR.	PACKAGING		UNIT PRICE €	
						Qty. per pack.	Qty. per pallet		
1	NX 64SE 5101	■			751	1	176		
	NX 64SE 5401	■			785	1	176	ECOGREEN ✓	
2	NX 64HG 5101		■		710	1	176		
	NX 64HG 5401		■		742	1	176	ECOGREEN ✓	
3	NX 64CR 5101			■	1016	1	176		
	NX 64CR 5401			■	1062	1	176	ECOGREEN ✓	
4	NX 64CV 5101	Cover			845	1	176		
	NX 64CV 5401	Cover			883	1	176	ECOGREEN ✓	
5	NX SEAL46 5113			2 x			500		
6	AT LOCK 8113		2 x				10		
7	LH TYT	Label holders for all sides					10		



1



2



3



4



5









6



7

DATASHEET

Separate lid	600 x 400 mm
1 Pieces per pack.	 1
Pieces per pallet / dimens.	 176 / 1200 x 800 x 870 H mm
Hinged lid	600 x 400 mm
2 Pieces per pack.	 1
Pieces per pallet / dimens.	 176 / 1200 x 800 x 870 H mm
2-parts lid	600 x 400 mm
3 Pieces per pack.	 1
Pieces per pallet / dimens.	 176 / 1200 x 800 x 870 H mm
Cover	600 x 400 mm
4 Pieces per pack.	 1
Pieces per pallet / dimens.	 176 / 1200 x 800 x 870 H mm
Disposable security seal	
5 Pieces per pack	 500
Pair closing clips	
6 Pieces per pack	 10
Label holders	
7 Pieces per pack	 10

iMilani srl reserves the right to alter the characteristics of products without notice. The values shown are nominal, with a +/- 1% tolerance for size, depending on the material, and a +/- 3% for weight.

	ARTICLE	WALLS		BOTTOM			HANDLES		GR.	PACKAGING		UNIT PRICE €
		Closed	Perforated	Closed	Perforated	Reinforced	Closed	Open		Qty. per pack.	Qty. per pallet	
	B NX 6417B 5101	■		■			■		1680	3	60	
	A NX 6417A 5401	■		■			■		1756	3	60	
	D NX 6417D 5101	■				■		■	2191	3	60	
	S NX 6417S 5101		■		■	■		■	2022	3	60	
	ARTICLE ON REQUEST											
	C NX 6417C 5401	■				■	■		2290	3	60	
	P NX 6417P 5401		■			■	■		2113	3	60	

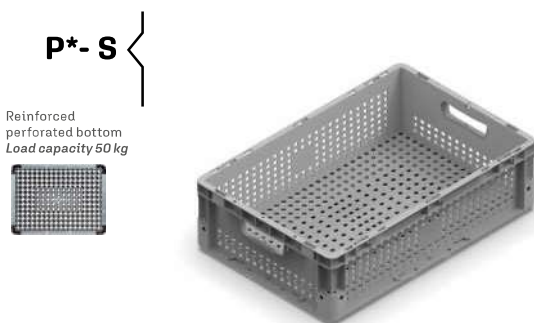

A - B	
Stacked edge height	155 mm
Usable stacked height / with lid	152 mm / 156 mm
Usable internal dimensions	561 x 361 x 167 H mm
Volume	14,7 L
Pieces per package / pallet	3 60
Package dimensions	620 x 420 x 515 H mm
Pallet dimensions	1200 x 800 x 2490 H mm
C - D	
Stacked edge height	155 mm
Usable stacked height / with lid	140 mm / 144 mm
Usable internal dimensions	561 x 361 x 155 H mm
Volume	11,8 L
Pieces per package / pallet	3 60
Package dimensions	620 x 420 x 515 H mm
Pallet dimensions	1200 x 800 x 2490 H mm
P - S	
Stacked edge height	155 mm
Usable stacked height / with lid	140 mm / 144 mm
Usable internal dimensions	561 x 361 x 155 H mm
Volume	11,8 L
Pieces per package / pallet	3 60
Package dimensions	620 x 420 x 515 H mm
Pallet dimensions	1200 x 800 x 2490 H mm

DATASHEET

* **ECOGREEN** with closed moulded handle







iMilani srl reserves the right to alter the characteristics of products without notice. The values shown are nominal, with a +/- 1% tolerance for size, depending on the material, and a +/- 3% for weight.

ARTICLES ON REQUEST

Minimum order.....200 boxes
Guaranteed shipping within.....60 days

600 x 400 mm

iMICUBE

	ARTICLE	SEPARATE LID	HINGED LID	2 PARTS LID	GR.	PACKAGING		UNIT PRICE €	
						Qty. per pack.	Qty. per pallet		
1	NX 64SE 5101	■			751	1	176		
	NX 64SE 5401	■			785	1	176	ECOGREEN ✓	
2	NX 64HG 5101		■		710	1	176		
	NX 64HG 5401		■		742	1	176	ECOGREEN ✓	
3	NX 64CR 5101			■	1016	1	176		
	NX 64CR 5401			■	1062	1	176	ECOGREEN ✓	
4	NX 64CV 5101	Cover			845	1	176		
	NX 64CV 5401				883	1	176	ECOGREEN ✓	
5	NX SEAL46 5113			2 x		500			
6	AT LOCK 8113		2 x			10			
7	LH TYT	Label holders for all sides				10			



1



2



3



4



5



6



7

DATASHEET

Separate lid	600 x 400 mm
1 Pieces per pack.	📦 1
Pieces per pallet / dimens.	🚚 176 / 1200 x 800 x 870 H mm
Hinged lid	600 x 400 mm
2 Pieces per pack.	📦 1
Pieces per pallet / dimens.	🚚 176 / 1200 x 800 x 870 H mm
2-parts lid	600 x 400 mm
3 Pieces per pack.	📦 1
Pieces per pallet / dimens.	🚚 176 / 1200 x 800 x 870 H mm
Cover	600 x 400 mm
4 Pieces per pack.	📦 1
Pieces per pallet / dimens.	🚚 176 / 1200 x 800 x 870 H mm
Disposable security seal	
5 Pieces per pack	📦 500
Pair closing clips	
6 Pieces per pack	📦 10
Label holders	
7 Pieces per pack	📦 10

iMilani srl reserves the right to alter the characteristics of products without notice. The values shown are nominal, with a +/- 1% tolerance for size, depending on the material, and a +/- 3% for weight.

600 x 400 mm H 220 mm

	ARTICLE	WALLS		BOTTOM			HANDLES		GR.	PACKAGING		UNIT PRICE €
		Closed	Perforated	Closed	Perforated	Reinforced	Closed	Open		Qty. per pack.	Qty. per pallet	
	B NX 6422B 5101	■		■			■		1901	2	40	
	A NX 6422A 5401	■		■			■		1987	2	40	
	D NX 6422D 5101	■				■	■		2421	2	40	
	ARTICLE ON REQUEST											
	C NX 6422C 5401	■				■	■		2530	2	40	

A* - B

Closed bottom
Load capacity 20 kg



C* - D

Reinforced bottom
Load capacity 50 kg



A - B

Stacked edge height	205 mm
Usable stacked height / with lid	202 mm / 206 mm
Usable internal dimensions	561 x 361 x 217 H mm
Volume	44,5 L
Pieces per package / pallet	2 40
Package dimensions	620 x 420 x 460 H mm
Pallet dimensions	1200 x 800 x 2215 H mm

C - D

Stacked edge height	205 mm
Usable stacked height / with lid	190 mm / 194 mm
Usable internal dimensions	561 x 361 x 205 H mm
Volume	41,7 L
Pieces per package / pallet	2 40
Package dimensions	620 x 420 x 460 H mm
Pallet dimensions	1200 x 800 x 2215 H mm

DATASHEET

* **ECOGREEN** with closed moulded handle

CONTINUED ON NEXT PAGE









iMilani srl reserves the right to alter the characteristics of products without notice. The values shown are nominal, with a +/- 1% tolerance for size, depending on the material, and a +/- 3% for weight.

ARTICLES ON REQUEST

Minimum order.....200 boxes
Guaranteed shipping within.....60 days

600 x 400 mm

iMICUBE

	ARTICLE	SEPARATE LID	HINGED LID	2 PARTS LID	GR.	PACKAGING		UNIT PRICE €	
						Qty. per pack.	Qty. per pallet		
1	NX 64SE 5101	■			751	1	176		
	NX 64SE 5401	■			785	1	176	ECOGREEN ✓	
2	NX 64HG 5101		■		710	1	176		
	NX 64HG 5401		■		742	1	176	ECOGREEN ✓	
3	NX 64CR 5101			■	1016	1	176		
	NX 64CR 5401			■	1062	1	176	ECOGREEN ✓	
4	NX 64CV 5101	Cover			845	1	176		
	NX 64CV 5401				883	1	176	ECOGREEN ✓	
5	NX SEAL46 5113			2 x			500		
6	AT LOCK 8113		2 x				10		
7	LH TYT	Label holders for all sides					10		



1



2



3



4



5



6



7

DATASHEET

Separate lid	600 x 400 mm
1 Pieces per pack.	📦 1
Pieces per pallet / dimens.	🚚 176 / 1200 x 800 x 870 H mm
Hinged lid	600 x 400 mm
2 Pieces per pack.	📦 1
Pieces per pallet / dimens.	🚚 176 / 1200 x 800 x 870 H mm
2-parts lid	600 x 400 mm
3 Pieces per pack.	📦 1
Pieces per pallet / dimens.	🚚 176 / 1200 x 800 x 870 H mm
Cover	600 x 400 mm
4 Pieces per pack.	📦 1
Pieces per pallet / dimens.	🚚 176 / 1200 x 800 x 870 H mm
Disposable security seal	
5 Pieces per pack	📦 500
Pair closing clips	
6 Pieces per pack	📦 10
Label holders	
7 Pieces per pack	📦 10

iMilani srl reserves the right to alter the characteristics of products without notice. The values shown are nominal, with a +/- 1% tolerance for size, depending on the material, and a +/- 3% for weight.

	ARTICLE	WALLS			BOTTOM			HANDLES		GR.	PACKAGING		UNIT PRICE €
		Closed	Perforated	Picking short side	Closed	Perforated	Reinforced	Closed	Open		Qty. per pack.	Qty. per pallet	
	S NX 6422S 5101	■				■	■		■	2164	2	40	
	U NX 6422U 5101			■	■				■	1838	2	40	
	ARTICLE ON REQUEST												
	P NX 6422P 5401	■				■	■	■		2261	2	40	
	V NX 6422V 5401			■	■			■		1921	2	40	

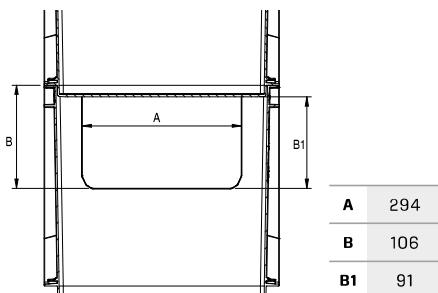
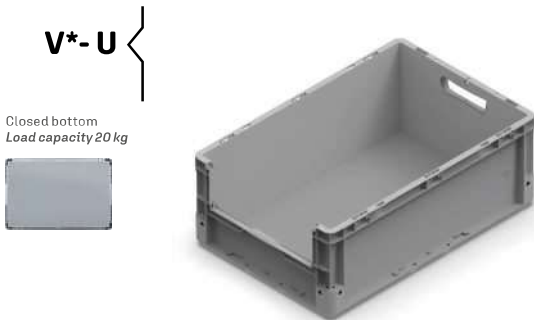
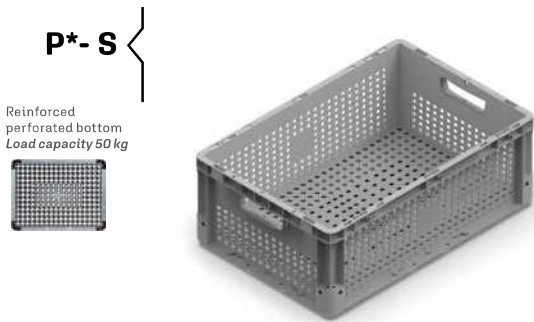

* **ECOGREEN** with closed moulded handle

◀◀ CONTINUED ON PREVIOUS PAGE

iMilani srl reserves the right to alter the characteristics of products without notice. The values shown are nominal, with a +/- 1% tolerance for size, depending on the material, and a +/- 3% for weight.

P-S

Stacked edge height	205 mm
Usable stacked height / with lid	190 mm / 194 mm
Usable internal dimensions	561 x 361 x 205 H mm
Volume	41,7 L
Pieces per package / pallet	2 40
Package dimensions	620 x 420 x 460 H mm
Pallet dimensions	1200 x 800 x 2215 H mm

V-U

Stacked edge height	205 mm
Usable stacked height / with lid	202 mm / 206 mm
Usable internal dimensions	561 x 361 x 217 H mm
Volume	44,5 L
Pieces per package / pallet	2 40
Package dimensions	620 x 420 x 460 H mm
Pallet dimensions	1200 x 800 x 2215 H mm

DATASHEET

ARTICLES ON REQUEST

Minimum order.....200 boxes
Guaranteed shipping within.....60 days

600 x 400 mm

iMICUBE

	ARTICLE	SEPARATE LID	HINGED LID	2 PARTS LID	GR.	PACKAGING		UNIT PRICE €	
						Qty. per pack.	Qty. per pallet		
1	NX 64SE 5101	■			751	1	176		
	NX 64SE 5401	■			785	1	176	♻️ ECOGREEN ✓	
2	NX 64HG 5101		■		710	1	176	♻️ PP	
	NX 64HG 5401		■		742	1	176	♻️ ECOGREEN ✓	
3	NX 64CR 5101			■	1016	1	176	♻️ PP	
	NX 64CR 5401			■	1062	1	176	♻️ ECOGREEN ✓	
4	NX 64CV 5101	Cover			845	1	176	♻️ PP	
	NX 64CV 5401				883	1	176	♻️ ECOGREEN ✓	
5	NX SEAL46 5113			2 x		500		♻️ PP	
6	AT LOCK 8113		2 x			10		♻️ PP	
7	LH TYT	Label holders for all sides				10		♻️ PP	
8	NX WC64226896	Door for H 220				10		♻️ PP	

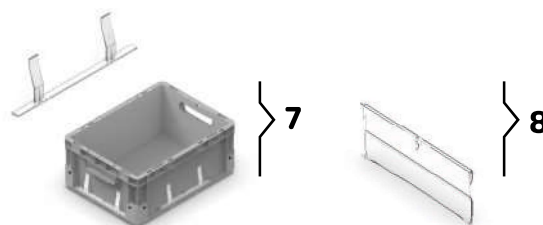

DATASHEET

Separate lid	600 x 400 mm
1 Pieces per pack.	📦 1
Pieces per pallet / dims.	📦 176 / 1200 x 800 x 870 H mm
Hinged lid	600 x 400 mm
2 Pieces per pack.	📦 1
Pieces per pallet / dims.	📦 176 / 1200 x 800 x 870 H mm
2-parts lid	600 x 400 mm
3 Pieces per pack.	📦 1
Pieces per pallet / dims.	📦 176 / 1200 x 800 x 870 H mm
Cover	600 x 400 mm
4 Pieces per pack.	📦 1
Pieces per pallet / dims.	📦 176 / 1200 x 800 x 870 H mm
Disposable security seal	
5 Pieces per pack	📦 500
Pair closing clips	
6 Pieces per pack	📦 10
Label holders	
7 Pieces per pack	📦 10
Door for H 220	
8 Pieces per pack	📦 1

iMilani srl reserves the right to alter the characteristics of products without notice. The values shown are nominal, with a +/- 1% tolerance for size, depending on the material, and a +/- 3% for weight.

	ARTICLE	WALLS		BOTTOM			HANDLES		GR.	PACKAGING		UNIT PRICE €
		Closed	Perforated	Closed	Perforated	Reinforced	Closed	Open		Qty. per pack.	Qty. per pallet	
♻️ ECOGREEN	B NX 6427B 5101	■		■				■	2133	2	32	
	B NX 6427B 5401	■		■				■	2229	2	32	
♻️ PP	D NX 6427D 5101	■				■		■	2654	2	32	
⚠️	ARTICLE ON REQUEST											
♻️ ECOGREEN	D NX 6427D 5401	■				■		■	2773	2	32	

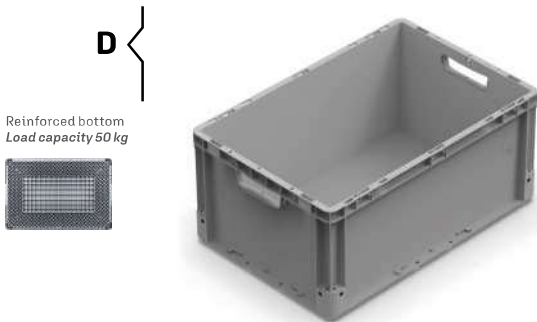
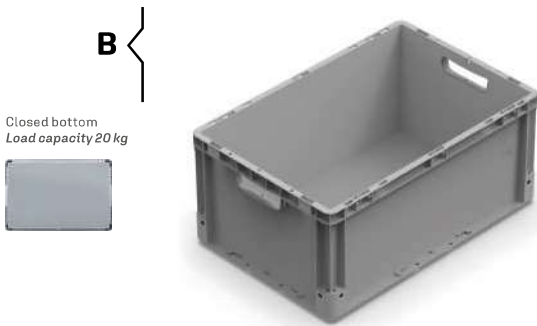

B	
Stacked edge height	255 mm
Usable stacked height / with lid	252 mm / 256 mm
Usable internal dimensions	561 x 361 x 267 H mm
Volume	54,8 L
Pieces per package / pallet	📦 2 🚚 32
Package dimensions	620 x 420 x 560 H mm
Pallet dimensions	1200 x 800 x 2205 H mm
D	
Stacked edge height	255 mm
Usable stacked height / with lid	240 mm / 244 mm
Usable internal dimensions	561 x 361 x 255 H mm
Volume	52 L
Pieces per package / pallet	📦 2 🚚 32
Package dimensions	620 x 420 x 560 H mm
Pallet dimensions	1200 x 800 x 2205 H mm

DATASHEET

CONTINUED ON NEXT PAGE



iMilani srl reserves the right to alter the characteristics of products without notice. The values shown are nominal, with a +/- 1% tolerance for size, depending on the material, and a +/- 3% for weight.

⚠️ ARTICLES ON REQUEST

Minimum order.....200 boxes
Guaranteed shipping within.....60 days

	ARTICLE	SEPARATE LID	HINGED LID	2 PARTS LID	GR.	PACKAGING		UNIT PRICE €	
						Qty. per pack.	Qty. per pallet		
1	NX 64SE 5101	■			751	1	176		
	NX 64SE 5401	■			785	1	176	♻️ ECOGREEN ✓	
2	NX 64HG 5101		■		710	1	176	♻️ PP	
	NX 64HG 5401		■		742	1	176	♻️ ECOGREEN ✓	
3	NX 64CR 5101			■	1016	1	176	♻️ PP	
	NX 64CR 5401			■	1062	1	176	♻️ ECOGREEN ✓	
4	NX 64CV 5101	Cover			845	1	176	♻️ PP	
	NX 64CV 5401				883	1	176	♻️ ECOGREEN ✓	
5	NX SEAL46 5113			2 x		500		♻️ PP	
6	AT LOCK 8113		2 x			10		♻️ PP	
7	LH TYT	Label holders for all sides				10		♻️ PP	



1



2



3



4



5



6



7

DATASHEET

Separate lid	600 x 400 mm
1 Pieces per pack.	📦 1
Pieces per pallet / dimens.	🚚 176 / 1200 x 800 x 870 H mm
Hinged lid	600 x 400 mm
2 Pieces per pack.	📦 1
Pieces per pallet / dimens.	🚚 176 / 1200 x 800 x 870 H mm
2-parts lid	600 x 400 mm
3 Pieces per pack.	📦 1
Pieces per pallet / dimens.	🚚 176 / 1200 x 800 x 870 H mm
Cover	600 x 400 mm
4 Pieces per pack.	📦 1
Pieces per pallet / dimens.	🚚 176 / 1200 x 800 x 870 H mm
Disposable security seal	
5 Pieces per pack	📦 500
Pair closing clips	
6 Pieces per pack	📦 10
Label holders	
7 Pieces per pack	📦 10

	ARTICLE	WALLS			BOTTOM			HANDLES		GR.	PACKAGING		UNIT PRICE €
		Closed	Perforated	Picking short side	Closed	Perforated	Reinforced	Closed	Open		Qty. per pack.	Qty. per pallet	
	S NX 6427S 5101	■				■	■		■	2394	2	32	
	U NX 6427U 5101			■	■				■	2056	2	32	
	ARTICLE ON REQUEST												
	S NX 6427S 5401	■				■	■	■		2502	2	32	
	U NX 6427U 5401			■	■				■	2149	2	32	

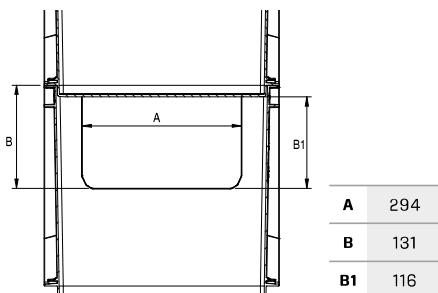
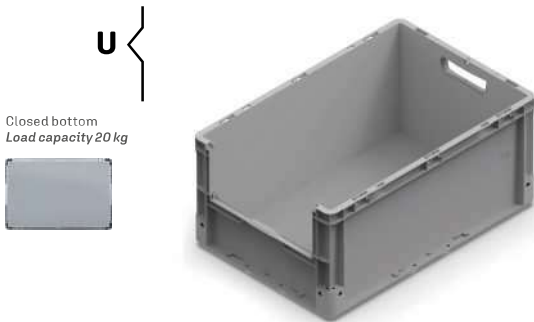
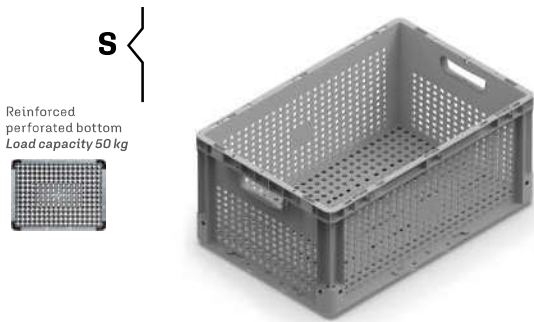









S	
Stacked edge height	255 mm
Usable stacked height / with lid	240 mm / 244 mm
Usable internal dimensions	561 x 361 x 255 H mm
Volume	52 L
Pieces per package / pallet	2 32
Package dimensions	620 x 420 x 560 H mm
Pallet dimensions	1200 x 800 x 2205 H mm
U	
Stacked edge height	255 mm
Usable stacked height / with lid	252 mm / 256 mm
Usable internal dimensions	561 x 361 x 267 H mm
Volume	54,8 L
Pieces per package / pallet	2 32
Package dimensions	620 x 420 x 560 H mm
Pallet dimensions	1200 x 800 x 2205 H mm

DATASHEET

« CONTINUED ON PREVIOUS PAGE

iMilani srl reserves the right to alter the characteristics of products without notice. The values shown are nominal, with a +/- 1% tolerance for size, depending on the material, and a +/- 3% for weight.

ARTICLES ON REQUEST
 Minimum order.....200 boxes
 Guaranteed shipping within.....60 days

	ARTICLE	SEPARATE LID	HINGED LID	2 PARTS LID	GR.	PACKAGING		UNIT PRICE €	
						Qty. per pack.	Qty. per pallet		
1	NX 64SE 5101	■			751	1	176		
	NX 64SE 5401	■			785	1	176	ECOGREEN ✓	
2	NX 64HG 5101		■		710	1	176		
	NX 64HG 5401		■		742	1	176	ECOGREEN ✓	
3	NX 64CR 5101			■	1016	1	176		
	NX 64CR 5401			■	1062	1	176	ECOGREEN ✓	
4	NX 64CV 5101	Cover			845	1	176		
	NX 64CV 5401	Cover			883	1	176	ECOGREEN ✓	
5	NX SEAL46 5113			2 x		500			
6	AT LOCK 8113		2 x			10			
7	LH TYT	Label holders for all sides				10			
8	NX WC64276896	Door for H270				1			



1



2



3



4



5



6





7



8

DATASHEET

Separate lid	600 x 400 mm
1 Pieces per pack.	 1
Pieces per pallet / dims.	 176 / 1200 x 800 x 870 H mm
Hinged lid	600 x 400 mm
2 Pieces per pack.	 1
Pieces per pallet / dims.	 176 / 1200 x 800 x 870 H mm
2-parts lid	600 x 400 mm
3 Pieces per pack.	 1
Pieces per pallet / dims.	 176 / 1200 x 800 x 870 H mm
Cover	600 x 400 mm
4 Pieces per pack.	 1
Pieces per pallet / dims.	 176 / 1200 x 800 x 870 H mm
Disposable security seal	
5 Pieces per pack	 500
Pair closing clips	
6 Pieces per pack	 10
Label holders	
7 Pieces per pack	 10
Door for H270	
8 Pieces per pack	 1

600 x 400 mm H 320 mm

	ARTICLE	WALLS		BOTTOM			HANDLES		GR.	PACKAGING		UNIT PRICE €
		Closed	Perforated	Closed	Perforated	Reinforced	Closed	Open		Qty. per pack.	Qty. per pallet	
♻️ B ECOGREEN	NX 6432B 5101	■		■				■	2423	3	40	
	NX 6432B 5401	■		■				■	2532	3	40	
♻️ D	NX 6432D 5101	■				■		■	2944	3	40	
⚠️	ARTICLE ON REQUEST											
♻️ D	NX 6432D 5401	■				■		■	3076	3	40	

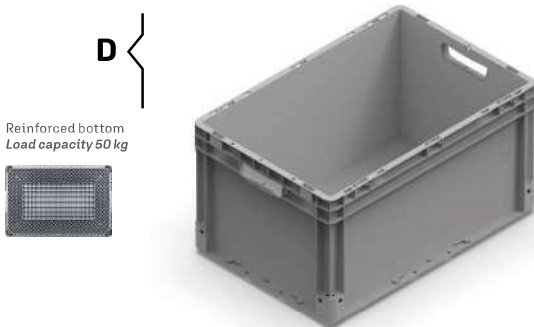
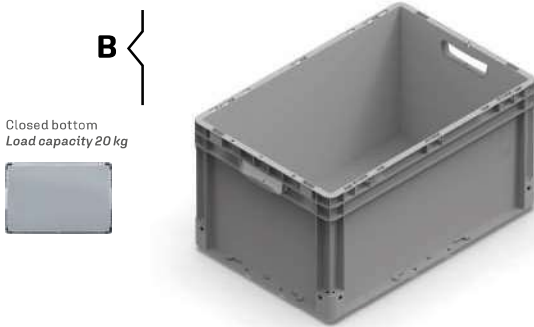

B	
Stacked edge height	305 mm
Usable stacked height / with lid	302 mm / 306 mm
Usable internal dimensions	561 x 361 x 317 H mm
Volume	65,1 L
Pieces per package / pallet	📦 3 🚚 40
Package dimensions	620 x 420 x 675 H mm
Pallet dimensions	1200 x 800 x 2390 H mm
D	
Stacked edge height	305 mm
Usable stacked height / with lid	290 mm / 294 mm
Usable internal dimensions	561 x 361 x 305 H mm
Volume	62,2 L
Pieces per package / pallet	📦 3 🚚 40
Package dimensions	620 x 420 x 675 H mm
Pallet dimensions	1200 x 800 x 2390 H mm

DATASHEET

CONTINUED ON NEXT PAGE









iMilani srl reserves the right to alter the characteristics of products without notice. The values shown are nominal, with a +/- 1% tolerance for size, depending on the material, and a +/- 3% for weight.

⚠️ ARTICLES ON REQUEST

Minimum order.....200 boxes
Guaranteed shipping within.....60 days

600 x 400 mm

iMICUBE

	ARTICLE	SEPARATE LID	HINGED LID	2 PARTS LID	GR.	PACKAGING		UNIT PRICE €	
						Qty. per pack.	Qty. per pallet		
1	NX 64SE 5101	■			751	1	176		
	NX 64SE 5401	■			785	1	176	ECOGREEN ✓	
2	NX 64HG 5101		■		710	1	176		
	NX 64HG 5401		■		742	1	176	ECOGREEN ✓	
3	NX 64CR 5101			■	1016	1	176		
	NX 64CR 5401			■	1062	1	176	ECOGREEN ✓	
4	NX 64CV 5101	Cover			845	1	176		
	NX 64CV 5401	Cover			883	1	176	ECOGREEN ✓	
5	NX SEAL46 5113			2 x		500			
6	AT LOCK 8113		2 x			10			
7	LH TYT	Label holders for all sides				10			



1



2



3



4



5



6



7

DATASHEET

Separate lid	600 x 400 mm
1 Pieces per pack.	📦 1
Pieces per pallet / dimens.	🚚 176 / 1200 x 800 x 870 H mm
Hinged lid	600 x 400 mm
2 Pieces per pack.	📦 1
Pieces per pallet / dimens.	🚚 176 / 1200 x 800 x 870 H mm
2-parts lid	600 x 400 mm
3 Pieces per pack.	📦 1
Pieces per pallet / dimens.	🚚 176 / 1200 x 800 x 870 H mm
Cover	600 x 400 mm
4 Pieces per pack.	📦 1
Pieces per pallet / dimens.	🚚 176 / 1200 x 800 x 870 H mm
Disposable security seal	
5 Pieces per pack	📦 500
Pair closing clips	
6 Pieces per pack	📦 10
Label holders	
7 Pieces per pack	📦 10

iMilani srl reserves the right to alter the characteristics of products without notice. The values shown are nominal, with a +/- 1% tolerance for size, depending on the material, and a +/- 3% for weight.

	ARTICLE	WALLS			BOTTOM			HANDLES		GR.	PACKAGING		UNIT PRICE €
		Closed	Perforated	Picking short side	Closed	Perforated	Reinforced	Closed	Open		Qty. per pack.	Qty. per pallet	
♻️	S NX 6432S 5101	■				■	■	■		2655	3	40	
♻️	U NX 6432U 5101			■	■				■	2323	3	40	
⚠️	ARTICLE ON REQUEST												
♻️	S NX 6432S 5401	■				■	■	■		2774	3	40	
♻️	U NX 6432U 5401			■	■				■	2428	3	40	

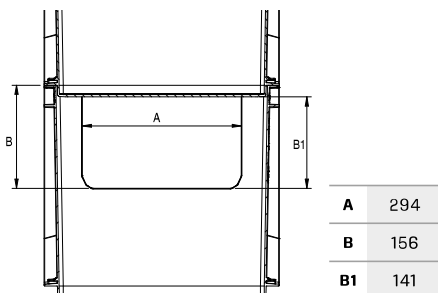
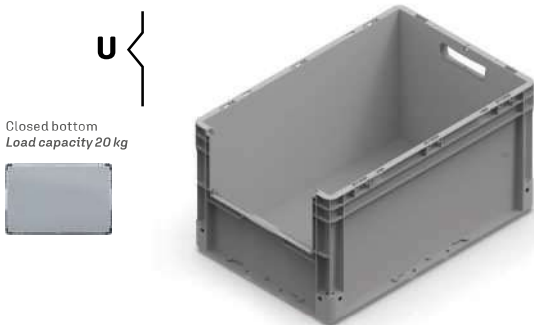
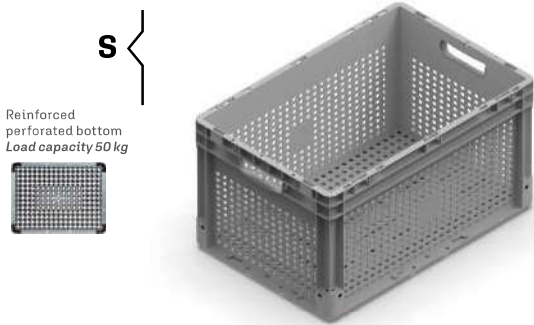









S	
Stacked edge height	305 mm
Usable stacked height / with lid	290 mm / 294 mm
Usable internal dimensions	561 x 361 x 305 H mm
Volume	62,2 L
Pieces per package / pallet	📦 3 🚚 40
Package dimensions	620 x 420 x 675 H mm
Pallet dimensions	1200 x 800 x 2390 H mm
U	
Stacked edge height	305 mm
Usable stacked height / with lid	302 mm / 306 mm
Usable internal dimensions	561 x 361 x 317 H mm
Volume	65,1 L
Pieces per package / pallet	📦 3 🚚 40
Package dimensions	620 x 420 x 675 H mm
Pallet dimensions	1200 x 800 x 2390 H mm

DATASHEET

◀ CONTINUED ON PREVIOUS PAGE

iMilani srl reserves the right to alter the characteristics of products without notice. The values shown are nominal, with a +/- 1% tolerance for size, depending on the material, and a +/- 3% for weight.

⚠️ ARTICLES ON REQUEST
 Minimum order.....200 boxes
 Guaranteed shipping within.....60 days

	ARTICLE	SEPARATE LID	HINGED LID	2 PARTS LID	GR.	PACKAGING		UNIT PRICE €	
						Qty. per pack.	Qty. per pallet		
1	NX 64SE 5101	■			751	1	176		
	NX 64SE 5401	■			785	1	176	ECOGREEN ✓	
2	NX 64HG 5101		■		710	1	176		
	NX 64HG 5401		■		742	1	176	ECOGREEN ✓	
3	NX 64CR 5101			■	1016	1	176		
	NX 64CR 5401			■	1062	1	176	ECOGREEN ✓	
4	NX 64CV 5101	Cover			845	1	176		
	NX 64CV 5401	Cover			883	1	176	ECOGREEN ✓	
5	NX SEAL46 5113			2 x		500			
6	AT LOCK 8113		2 x			10			
7	LH TYT	Label holders for all sides				10			
8	NX WC64326896	Door for H 320				1			



1



2



3



4



5



6







7



8

DATASHEET

Separate lid	600 x 400 mm
1 Pieces per pack.	 1
Pieces per pallet / dims.	 176 / 1200 x 800 x 870 H mm
Hinged lid	600 x 400 mm
2 Pieces per pack.	 1
Pieces per pallet / dims.	 176 / 1200 x 800 x 870 H mm
2-parts lid	600 x 400 mm
3 Pieces per pack.	 1
Pieces per pallet / dims.	 176 / 1200 x 800 x 870 H mm
Cover	600 x 400 mm
4 Pieces per pack.	 1
Pieces per pallet / dims.	 176 / 1200 x 800 x 870 H mm
Disposable security seal	
5 Pieces per pack	 500
Pair closing clips	
6 Pieces per pack	 10
Label holders	
7 Pieces per pack	 10
Door for H 320	
8 Pieces per pack	 1

600 x 400 mm H 420 mm

	ARTICLE	WALLS		BOTTOM			HANDLES		GR.	PACKAGING		UNIT PRICE €
		Closed	Perforated	Closed	Perforated	Reinforced	Closed	Open		Qty. per pack.	Qty. per pallet	
♻️ B ECOGREEN	NX 6442B 5101	■		■			■		2886	1	20	
	NX 6442B 5401	■		■			■		3016	1	20	
♻️ D	NX 6442D 5101	■				■		■	3407	1	20	
⚠️	ARTICLE ON REQUEST											
♻️ D	NX 6442D 5401	■				■	■		3560	1	20	

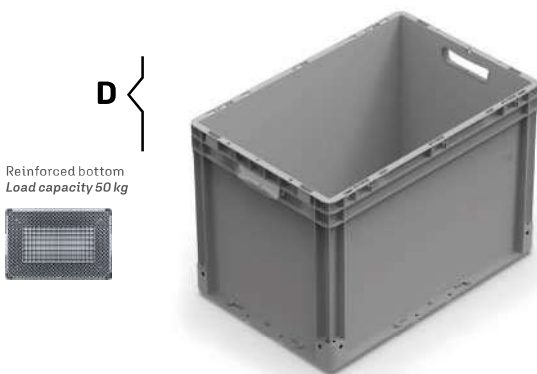
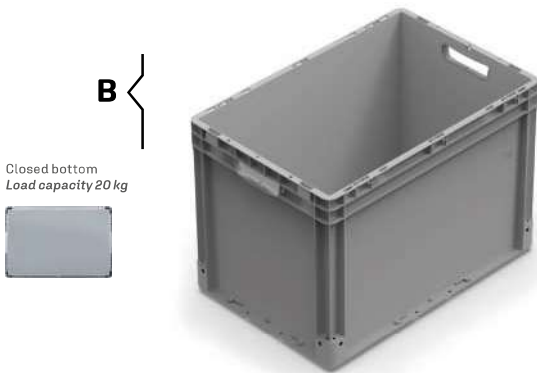

B	
Stacked edge height	405 mm
Usable stacked height / with lid	402 mm / 406 mm
Usable internal dimensions	561 x 361 x 417 H mm
Volume	85,6 L
Pieces per package / pallet	📦 1 🚚 20
Package dimensions	620 x 420 x 455 H mm
Pallet dimensions	1200 x 800 x 2190 H mm
D	
Stacked edge height	405 mm
Usable stacked height / with lid	390 mm / 394 mm
Usable internal dimensions	561 x 361 x 405 H mm
Volume	82,8 L
Pieces per package / pallet	📦 1 🚚 20
Package dimensions	620 x 420 x 455 H mm
Pallet dimensions	1200 x 800 x 2190 H mm

DATASHEET

CONTINUED ON NEXT PAGE



iMilani srl reserves the right to alter the characteristics of products without notice. The values shown are nominal, with a +/- 1% tolerance for size, depending on the material, and a +/- 3% for weight.

⚠️ ARTICLES ON REQUEST

Minimum order.....200 boxes
Guaranteed shipping within.....60 days

	ARTICLE	SEPARATE LID	HINGED LID	2 PARTS LID	GR.	PACKAGING		UNIT PRICE €	
						Qty. per pack.	Qty. per pallet		
1	NX 64SE 5101	■			751	1	176		
	NX 64SE 5401	■			785	1	176	♻️ ECOGREEN ✓	
2	NX 64HG 5101		■		710	1	176	♻️ PP	
	NX 64HG 5401		■		742	1	176	♻️ ECOGREEN ✓	
3	NX 64CR 5101			■	1016	1	176	♻️ PP	
	NX 64CR 5401			■	1062	1	176	♻️ ECOGREEN ✓	
4	NX 64CV 5101	Cover			845	1	176	♻️ PP	
	NX 64CV 5401	Cover			883	1	176	♻️ ECOGREEN ✓	
5	NX SEAL46 5113			2 x		500		♻️ PP	
6	AT LOCK 8113		2 x			10		♻️ PP	
7	LH TYT	Label holders for all sides				10		♻️ PP	



1



2



3



4



5



6



7

DATASHEET

Separate lid	600 x 400 mm
1 Pieces per pack.	📦 1
Pieces per pallet / dimens.	🚚 176 / 1200 x 800 x 870 H mm
Hinged lid	600 x 400 mm
2 Pieces per pack.	📦 1
Pieces per pallet / dimens.	🚚 176 / 1200 x 800 x 870 H mm
2-parts lid	600 x 400 mm
3 Pieces per pack.	📦 1
Pieces per pallet / dimens.	🚚 176 / 1200 x 800 x 870 H mm
Cover	600 x 400 mm
4 Pieces per pack.	📦 1
Pieces per pallet / dimens.	🚚 176 / 1200 x 800 x 870 H mm
Disposable security seal	
5 Pieces per pack	📦 500
Pair closing clips	
6 Pieces per pack	📦 10
Label holders	
7 Pieces per pack	📦 10

	ARTICLE	WALLS			BOTTOM			HANDLES		GR.	PACKAGING		UNIT PRICE €
		Closed	Perforated	Picking short side	Closed	Perforated	Reinforced	Closed	Open		Qty. per pack.	Qty. per pallet	
	S NX 6442S 5101	■				■	■		■	3018	1	20	
	U NX 6442U 5101			■	■				■	2759	1	20	
	ARTICLE ON REQUEST												
	S NX 6442S 5401	■				■	■	■		3154	1	20	
	U NX 6442U 5401			■	■				■	2883	1	20	

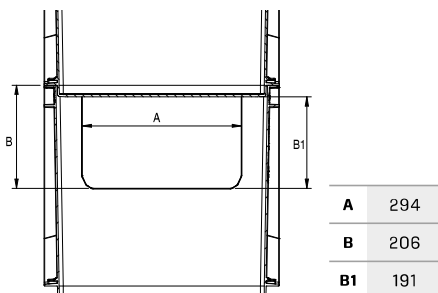
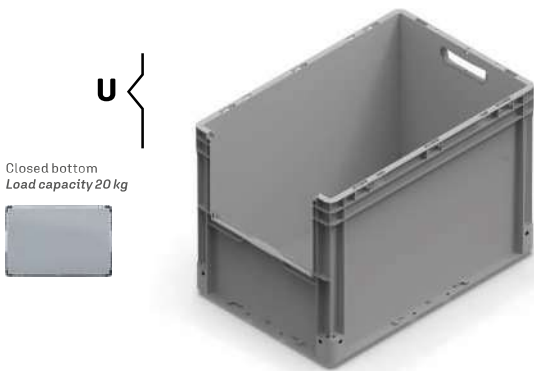
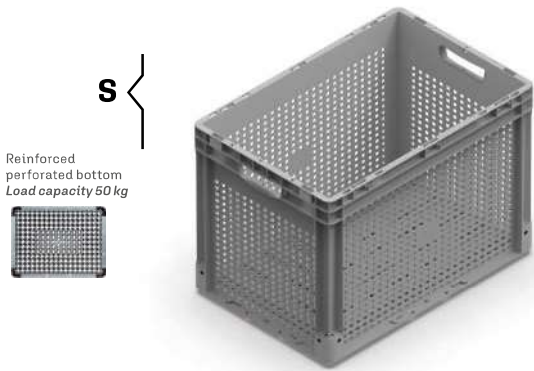

S

Stacked edge height	405 mm
Usable stacked height / with lid	390 mm / 394 mm
Usable internal dimensions	561 x 361 x 405 H mm
Volume	82,8 L
Pieces per package / pallet	1 20
Package dimensions	620 x 420 x 455 H mm
Pallet dimensions	1200 x 800 x 2190 H mm

U

Stacked edge height	405 mm
Usable stacked height / with lid	402 mm / 406 mm
Usable internal dimensions	561 x 361 x 417 H mm
Volume	85,6 L
Pieces per package / pallet	1 20
Package dimensions	620 x 420 x 455 H mm
Pallet dimensions	1200 x 800 x 2190 H mm

DATASHEET









« CONTINUED ON PREVIOUS PAGE

iMilani srl reserves the right to alter the characteristics of products without notice. The values shown are nominal, with a +/- 1% tolerance for size, depending on the material, and a +/- 3% for weight.

ARTICLES ON REQUEST
 Minimum order.....200 boxes
 Guaranteed shipping within.....60 days

600 x 400 mm

iMICUBE

	ARTICLE	SEPARATE LID	HINGED LID	2 PARTS LID	GR.	PACKAGING		UNIT PRICE €	
						Qty. per pack.	Qty. per pallet		
1	NX 64SE 5101	■			751	1	176		
	NX 64SE 5401	■			785	1	176	ECOGREEN ✓	
2	NX 64HG 5101		■		710	1	176		
	NX 64HG 5401		■		742	1	176	ECOGREEN ✓	
3	NX 64CR 5101			■	1016	1	176		
	NX 64CR 5401			■	1062	1	176	ECOGREEN ✓	
4	NX 64CV 5101	Cover			845	1	176		
	NX 64CV 5401	Cover			883	1	176	ECOGREEN ✓	
5	NX SEAL46 5113			2 x			500		
6	AT LOCK 8113		2 x				10		
7	LH TYT	Label holders for all sides					10		
8	NX WC64426896	Door for H 420					1		



1



2



3



4



5



6





7



8

DATASHEET

Separate lid	600 x 400 mm
1 Pieces per pack.	 1
Pieces per pallet / dims.	 176 / 1200 x 800 x 870 H mm
Hinged lid	600 x 400 mm
2 Pieces per pack.	 1
Pieces per pallet / dims.	 176 / 1200 x 800 x 870 H mm
2-parts lid	600 x 400 mm
3 Pieces per pack.	 1
Pieces per pallet / dims.	 176 / 1200 x 800 x 870 H mm
Cover	600 x 400 mm
4 Pieces per pack.	 1
Pieces per pallet / dims.	 176 / 1200 x 800 x 870 H mm
Disposable security seal	
5 Pieces per pack	 500
Pair closing clips	
6 Pieces per pack	 10
Label holders	
7 Pieces per pack	 10
Door for H 420	
8 Pieces per pack	 1

iMilani srl reserves the right to alter the characteristics of products without notice. The values shown are nominal, with a +/- 1% tolerance for size, depending on the material, and a +/- 3% for weight.

600 x 400 mm

iMICUBE

NEXIT

84

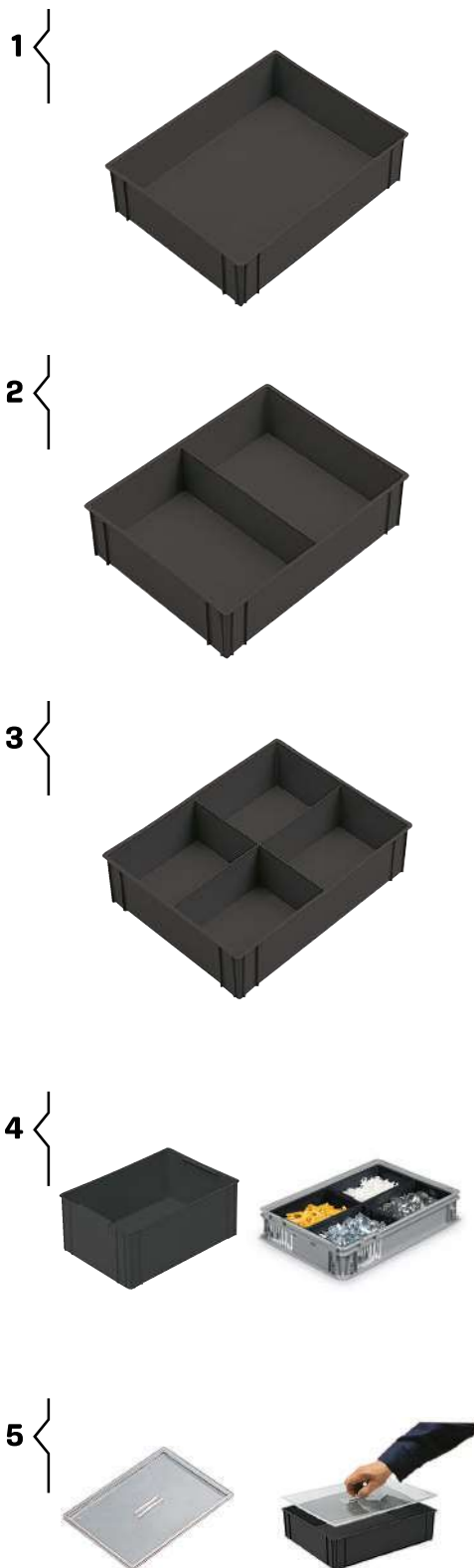

ARTICLE	1 SÉPARATION	2 SÉPARATIONS	4 SÉPARATIONS	GR.	EMBALLAGE		PRIX UNITAIRE €
					Qté par paq.	Qté par palette	
ECOGREEN ✓ 1 AT 64S1 5407	■			428	10	160	
ECOGREEN ✓ 2 AT 64S2 5407		■		460	10	160	
ECOGREEN ✓ 3 AT 64S4 5407			■	489	10	160	
ECOGREEN ✓ 4 AT 64S0 5407	■			345	20	320	
5 AT LID6 6896	Transparent lid					20	

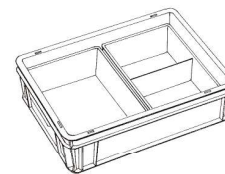

Subdivision with 1 and 2 compartments



Subdivision with 1 and 4 compartments



Subdivision with 2 and 4 compartments

1	Partitioned box 1 partition	357 x 278 x 90 H mm
	Pieces per pack / pallet	📦 10 🚚 160
	Package dimensions	565 x 375 x 460 H mm
	Pallet dimensions	1200 x 800 x 1990 H mm
2	Partitioned box 2 partitions	357 x 278 x 90 H mm
	Pieces per pack / pallet	📦 10 🚚 160
	Package dimensions	565 x 375 x 460 H mm
	Pallet dimensions	1200 x 800 x 1990 H mm
3	Partitioned box 4 partitions	357 x 278 x 90 H mm
	Pieces per pack / pallet	📦 10 🚚 160
	Package dimensions	565 x 375 x 460 H mm
	Pallet dimensions	1200 x 800 x 1990 H mm
4	Partitioned box 1 partition	277 x 177 x 99 H mm
	Pieces per pack / pallet	📦 20 🚚 320
	Package dimensions	565 x 375 x 460 H mm
	Pallet dimensions	1200 x 800 x 1990 H mm
5	Transparent polystyrene lid	
	Pieces per pack / pallet	📦 20
Package dimensions		365 x 295 x 180 H mm

DATASHEET

600 x 400 mm

	ARTICLE	H 45	H 70	H 90	H 120	H 180	H 220	PACKAGING		UNIT PRICE €
								Qty. per pack.	Qty. per pallet	
1	DI 35545246801	■						10		PS
	DI 55545246801	■						10		
2	DI 35570246801		■					10		PS
	DI 55570246801		■					10		
3	DI 35590246801			■				10		PS
	DI 55590246801			■				10		
4	DI 35512246801				■			10		PS
	DI 55512246801				■			10		
5	DI 35518246801					■		10		PS
	DI 55518246801					■		10		
6	DI 35522246801						■	10		PS
	DI 55522246801						■	10		
7	DI 64SHT 5101							10		PS

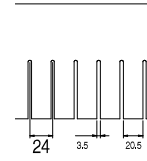

6801

Pitch 24 mm

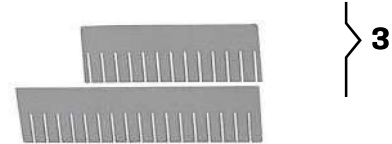

DATASHEET

1	Comb divider 355 x 45 H mm per box 600 x 400 x 75 H mm	10 items
	Comb divider 555 x 45 H mm per box 600 x 400 x 75 H mm	10 items
2	Comb divider 355 x 70 H mm per box 600 x 400 x 120 H mm	10 items
	Comb divider 555 x 70 H mm per box 600 x 400 x 120 H mm	10 items
3	Comb divider 355 x 90 H mm per box 600 x 400 x 120 H mm	10 items
	Comb divider 555 x 90 H mm per box 600 x 400 x 120 H mm	10 items
4	Comb divider 355 x 120 H mm per box 600 x 400 x 170 H mm	10 items
	Comb divider 555 x 120 H mm per box 600 x 400 x 170 H mm	10 items
5	Comb divider 355 x 180 H mm per box 600 x 400 x 220 H mm	10 items
	Comb divider 555 x 180 H mm per box 600 x 400 x 220 H mm	10 items
6	Comb divider 355 x 220 H mm per box 600 x 400 x 270 H mm	10 items
	Comb divider 555 x 220 H mm per box 600 x 400 x 270 H mm	10 items
7	Intermediate partition shelf 555 x 355 mm	10 items



ATHENA

The variety of materials and sizes of the **ATHENA** series of boxes make them suitable for use in all sectors, with optimal adaptability to storage and distribution requirements. They are stackable with and without lids and conform to euro-pallet sizes.

Edges and reinforcements are designed to give the boxes structural strength to withstand the heaviest loads. The bottoms and walls of the boxes can be closed or perforated.

The handles can also be in open or closed mode. The varied composition of these elements permits a wide range of solutions and does not exclude the option of customised solutions.

BOTTOM

MICUBE

800x600 mm
bottom for accessories

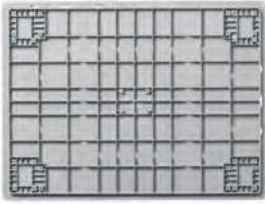

ACCESSORIES

with feet



with crossbars



with wheels



to add to the feet



ARTICLE	WALLS		BOTTOM			HANDLES		GR.	PACKAGING		UNIT PRICE €	
	Closed	Perforated	Closed	Perforated	Reinforced	Closed	Open		Qty. per pack.	Qty. per pallet		
AT 8612C 5101	■				■	■		3458	4	40		
AT 8612C 5207	■				■	■		3873	4	40		
AT 8612C 5401	■				■	■		3614	4	40		
ACCESSORIES												
AT FEET 5101	Foot							136	1			
AT FEET 5207	Foot							152	1			
AT FEET 5401	Foot							142	1			
AT RUNN 5101	Crossbar to be slotted under the feet AT FEET							382	1			
AT RUNN 5207	Crossbar to be slotted under the feet AT FEET							428	1			
AT RUNN 5401	Crossbar to be slotted under the feet AT FEET							400	1			
AT WRCT 100	Swivel wheel D. 100 mm in rubber								1			
AT WRCT 125	Swivel wheel D. 125 mm in rubber								1			

C

Reinforced bottom
Load capacity 60 kg



1



Order 4 feet

2



Order 2 crossbars

3



Order 4 wheels
AT WRCT 100/125
or alternatively those on
the opposite page

All accessories include fixing screws when required

Accessories supplied mounted
When fitted with wheels, the boxes are not stackable

iMilani srl reserves the right to alter the characteristics of products without notice. The values shown are nominal, with a +/- 1% tolerance for size, depending on the material, and a +/- 3% for weight.

C

Stacked edge height	105 mm
Usable stacked height / with lid	86 mm / 93 mm
Usable internal dimensions	755 x 555 x 101 H mm
Volume	49 L
Pieces per package / pallet	4 40
Package dimensions	820 x 620 x 455 H mm
Pallet dimensions	1200 x 800 x 2265 H mm
1	
Feet with fixing screws	100 H mm
Pieces per package	1
2	
Crossbar	25 H mm
Pieces per package	1
3	
Swivel wheel in rubber	diamètre 100/125 mm
Pieces per package	1

DATASHEET

800 x 600 mm H 120 mm

iMICUBE

ARTICLE	SEPARATE LID	GR.	PACKAGING		UNIT PRICE €
			Qty. per pack.	Qty. per pallet	
AT 86SE 5101	■	1978	5	60	
1 AT 86SE 5207	■	2215	5	60	
AT 86SE 5401	■	2067	5	60	
2 SPRING 0099	Document holder spring		10		
3 AT WRBT 100	Swivel wheel in rubber w/brake D. 100 mm		1		
AT WRBT 125	Swivel wheel in rubber w/brake D. 125 mm		1		
4 AT WRCF 100	Swivel wheel in rubber D. 100 mm		1		
AT WRCF 125	Swivel wheel in rubber D. 125 mm		1		
5 AT WNBT 100	Swivel wheel in nylon w/brake D. 100 mm		1		
AT WNBT 125	Swivel wheel in nylon w/brake D. 125 mm		1		
6 AT WNCF 100	Fixed wheel in nylon D. 100 mm		1		
AT WNCF 125	Fixed wheel in nylon D. 125 mm		1		
7 AT WHBT 125	Swivel wheel non-marking rubber w/brake D. 125 mm		1		
8 AT WHCF 125	Fixed wheel non-marking rubber D. 125 mm		1		



ECOGREEN



All accessories include fixing screws when required

DATASHEET

1	Separate lid	800 x 600 mm
	Pieces per pack / pallet	5 60
	Package dimensions	800 x 600 x 150 H mm
	Pallet dimensions	1200 x 800 x 860 H mm
2	Document holder spring	
	Pieces per package	10
3	Swivel wheel in rubber with brake D. 100 mm footprint 128 H mm	
	Swivel wheel in rubber with brake D. 125 mm footprint 155 H mm	
4	Rubber fixed wheel diameter 100 mm - footprint 128 mm H	
	Rubber fixed wheel diameter 125 mm - footprint 155 mm H	
5	Swivel wheel in nylon with brake diameter 100 mm footprint 128 H mm	
	Swivel wheel in nylon with brake diameter 125 mm footprint 155 H mm	
6	Fixed wheel in nylon diameter 100 mm footprint 128 mm H	
	Fixed wheel in nylon diameter 125 mm footprint 155 mm H	
7	Swivel wheel in non-marking rubber with brake diameter 125 mm - footprint 155 H mm	
8	Fixed wheel in non-marking rubber diameter 125 mm - footprint 155 H mm	



iMilani srl reserves the right to alter the characteristics of products without notice. The values shown are nominal, with a +/- 1% tolerance for size, depending on the material, and a +/- 3% for weight.

ARTICLE	WALLS		BOTTOM			HANDLES		GR.	PACKAGING		UNIT PRICE €	
	Closed	Perforated	Closed	Perforated	Reinforced	Closed	Open		Qty. per pack.	Qty. per pallet		
AT 8617C 5101	■				■	■		3804	3	28		
AT 8617C 5207	■				■	■		4260	3	28		
AT 8617C 5401	■				■	■		3975	3	28		
ACCESSORIES												
AT FEET 5101	Foot							136	1			
AT FEET 5207	Foot							152	1			
AT FEET 5401	Foot							142	1			
AT RUNN 5101	Crossbar to be slotted under the feet AT FEET							382	1			
AT RUNN 5207	Crossbar to be slotted under the feet AT FEET							428	1			
AT RUNN 5401	Crossbar to be slotted under the feet AT FEET							400	1			
AT WRCT 100	Swivel wheel D. 100 mm in rubber								1			
AT WRCT 125	Swivel wheel D. 125 mm in rubber								1			

C

Reinforced bottom
Load capacity 60 kg



1

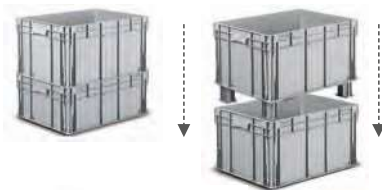

Order 4 feet

2



Order 2 crossbars

3



Order 4 wheels
AT WRCT 100/125
or alternatively those on
the opposite page

All accessories include fixing screws when required

Accessories supplied mounted

iMilani srl reserves the right to alter the characteristics of products without notice. The values shown are nominal, with a +/- 1% tolerance for size, depending on the material, and a +/- 3% for weight.

C	
Stacked edge height	155 mm
Usable stacked height / with lid	136 mm / 143 mm
Usable internal dimensions	755 x 555 x 151 H mm
Volume	69 L
Pieces per package / pallet	3 28
Package dimensions	820 x 620 x 500 H mm
Pallet dimensions	1200 x 800 x 2335 H mm
1	
Feet with fixing screws	100 H mm
Pieces per package	1
2	
Crossbar	25 H mm
Pieces per package	1
3	
Swivel wheel in rubber	diamètre 100/125 mm
Pieces per package	1

800 x 600 mm H 170 mm



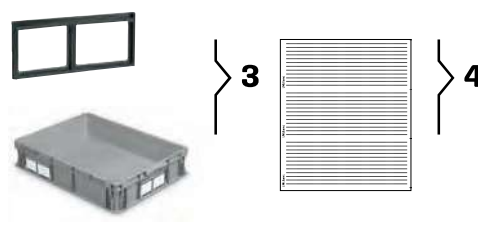

iMICUBE

ARTICLE	SEPARATE LID	GR.	PACKAGING		UNIT PRICE €
			Qty. per pack.	Qty. per pallet	
1 AT 86SE 5101	■	1978	5	60	
AT 86SE 5207	■	2215	5	60	
AT 86SE 5401	■	2067	5	60	
2 SPRING 0099	Document holder spring		10		
3 AT LH64 5107	Label holders		10		
4 LB 21081 0325	A4 sheet with 3 labels		25		
5 AT WRBT 100	Swivel wheel in rubber w/brake D. 100 mm		1		
AT WRBT 125	Swivel wheel in rubber w/brake D. 125 mm		1		
6 AT WRCF 100	Swivel wheel in rubber D. 100 mm		1		
AT WRCF 125	Swivel wheel in rubber D. 125 mm		1		
7 AT WNBT 100	Swivel wheel in nylon w/brake D. 100 mm		1		
AT WNBT 125	Swivel wheel in nylon w/brake D. 125 mm		1		
8 AT WNCF 100	Fixed wheel in nylon D. 100 mm		1		
AT WNCF 125	Fixed wheel in nylon D. 125 mm		1		
9 AT WHBT 125	Swivel wheel non-marking rubber w/brake D. 125 mm		1		
10 AT WHCF 125	Fixed wheel non-marking rubber D. 125 mm		1		



 All accessories include fixing screws when required

DATASHEET

Separate lid	800 x 600 mm
1 Pieces per pack / pallet	 5  60
Package dimensions	800 x 600 x 150 H mm
Pallet dimensions	1200 x 800 x 860 H mm
Document holder spring	
2 Pieces per package	 10
Label holders	215 x 85 H mm
3 Pieces per package	 10
A4 sheet with 3 labels	210 x 81 H mm
4 Pieces per package	 25
Swivel wheel in rubber with brake D. 100 mm footprint 128 H mm	
5 Swivel wheel in rubber with brake D. 125 mm footprint 155 H mm	
Rubber fixed wheel diameter 100 mm - footprint 128 mm H	
6 Rubber fixed wheel diameter 125 mm - footprint 155 mm H	
Swivel wheel in nylon with brake diameter 100 mm footprint 128 H mm	
7 Swivel wheel in nylon with brake diameter 125 mm footprint 155 H mm	
Fixed wheel in nylon diameter 100 mm footprint 128 mm H	
8 Fixed wheel in nylon diameter 125 mm footprint 155 mm H	
Swivel wheel in non-marking rubber with brake diameter 125 mm - footprint 155 H mm	
9 Fixed wheel in non-marking rubber diameter 125 mm - footprint 155 H mm	
10	

iMilani srl reserves the right to alter the characteristics of products without notice. The values shown are nominal, with a +/- 1% tolerance for size, depending on the material, and a +/- 3% for weight.

Reinforced bottom
Load capacity 60 kg



C

1



Order 4 feet

2



Order 2 crossbars

3



Order 4 wheels
AT WRCT 100/125
or alternatively those on
the opposite page

Accessories supplied mounted

iMilani srl reserves the right to alter the characteristics of products without notice. The values shown are nominal, with a +/- 1% tolerance for size, depending on the material, and a +/- 3% for weight.

ARTICLE	WALLS		BOTTOM			HANDLES		GR.	PACKAGING		UNIT PRICE €
	Closed	Perforated	Closed	Perforated	Reinforced	Closed	Open		Qty. per pack.	Qty. per pallet	
AT 8622C 5101	■				■	■		4588	2	20	
AT 8622C 5207	■				■	■		5138	2	20	
AT 8622C 5401	■				■	■		4795	2	20	
ACCESSORIES											
AT FEET 5101	Foot							136	1		
AT FEET 5207	Order 4 pieces							152	1		
AT FEET 5401								142	1		
AT RUNN 5101	Crossbar to be slotted under the feet AT FEET							382	1		
AT RUNN 5207	Order 2 pieces							428	1		
AT RUNN 5401								400	1		
AT WRCT 100	Swivel wheel D. 100 mm in rubber								1		
AT WRCT 125	Swivel wheel D. 125 mm in rubber								1		

All accessories include fixing screws when required

C	
Stacked edge height	205 mm
Usable stacked height / with lid	186 mm / 193 mm
Usable internal dimensions	755 x 555 x 201 H mm
Volume	90 L
Pieces per package / pallet	2 20
Package dimensions	820 x 620 x 445h H mm
Pallet dimensions	1200 x 800 x 2215 H mm
1	
Feet with fixing screws	100 H mm
Pieces per package	1
2	
Crossbar	25 H mm
Pieces per package	1
3	
Swivel wheel in rubber	diamètre 100/125 mm
Pieces per package	1

ARTICLE	SEPARATE LID	GR.	PACKAGING		UNIT PRICE €
			Qty. per pack.	Qty. per pallet	
1 AT 86SE 5101	■	1978	5	60	
AT 86SE 5207	■	2215	5	60	
AT 86SE 5401	■	2067	5	60	
2 SPRING 0099	Document holder spring		10		
3 AT LH64 5107	Label holders		10		
4 LB 21081 0325	A4 sheet with 3 labels		25		
5 AT WRBT 100	Swivel wheel in rubber w/brake D. 100 mm		1		
AT WRBT 125	Swivel wheel in rubber w/brake D. 125 mm		1		
6 AT WRCF 100	Swivel wheel in rubber D. 100 mm		1		
AT WRCF 125	Swivel wheel in rubber D. 125 mm		1		
7 AT WNBT 100	Swivel wheel in nylon w/brake D. 100 mm		1		
AT WNBT 125	Swivel wheel in nylon w/brake D. 125 mm		1		
8 AT WNCF 100	Fixed wheel in nylon D. 100 mm		1		
AT WNCF 125	Fixed wheel in nylon D. 125 mm		1		
9 AT WHBT 125	Swivel wheel non-marking rubber w/brake D. 125 mm		1		
10 AT WHCF 125	Fixed wheel non-marking rubber D. 125 mm		1		

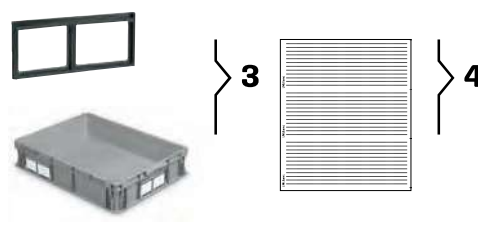

All accessories include fixing screws when required

DATASHEET

Separate lid	800 x 600 mm
1 Pieces per pack / pallet	5 60
Package dimensions	800 x 600 x 150 H mm
Pallet dimensions	1200 x 800 x 860 H mm
Document holder spring	
2 Pieces per package	10
Label holders	215 x 85 H mm
3 Pieces per package	10
A4 sheet with 3 labels	210 x 81 H mm
4 Pieces per package	25
Swivel wheel in rubber with brake D. 100 mm footprint 128 H mm	
5 Swivel wheel in rubber with brake D. 125 mm footprint 155 H mm	
Rubber fixed wheel diameter 100 mm - footprint 128 mm H	
6 Rubber fixed wheel diameter 125 mm - footprint 155 mm H	
Swivel wheel in nylon with brake diameter 100 mm footprint 128 H mm	
7 Swivel wheel in nylon with brake diameter 125 mm footprint 155 H mm	
Fixed wheel in nylon diameter 100 mm footprint 128 mm H	
8 Fixed wheel in nylon diameter 125 mm footprint 155 mm H	
Swivel wheel in non-marking rubber with brake diameter 125 mm - footprint 155 H mm	
9 Fixed wheel in non-marking rubber diameter 125 mm - footprint 155 H mm	
10	

iMilani srl reserves the right to alter the characteristics of products without notice. The values shown are nominal, with a +/- 1% tolerance for size, depending on the material, and a +/- 3% for weight.

Reinforced bottom
Load capacity 60 kg



C



1



Order 4 feet

2



Order 2 crossbars

3

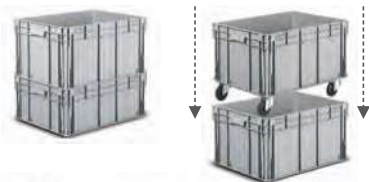

Order 4 wheels
AT WRCT 100/125
or alternatively those on
the opposite page

Accessories supplied mounted

iMilani srl reserves the right to alter the characteristics of products without notice. The values shown are nominal, with a +/- 1% tolerance for size, depending on the material, and a +/- 3% for weight.

ARTICLE	WALLS		BOTTOM			HANDLES		GR.	PACKAGING		UNIT PRICE €
	Closed	Perforated	Closed	Perforated	Reinforced	Closed	Open		Qty. per pack.	Qty. per pallet	
AT 8632C 5101	■				■	■		5422	2	14	
C AT 8632C 5207	■				■	■		6072	2	14	
ECOGREEN ✓ AT 8632C 5401	■				■	■		5665	2	14	
ACCESSORIES											
AT FEET 5101	Foot							136	1		
1 AT FEET 5207	Order 4 pieces							152	1		
ECOGREEN ✓ AT FEET 5401								142	1		
AT RUNN 5101	Crossbar to be slotted under the feet AT FEET							382	1		
2 AT RUNN 5207	Order 2 pieces							428	1		
ECOGREEN ✓ AT RUNN 5401								400	1		
3 AT WRCT 100	Swivel wheel D. 100 mm in rubber								1		
AT WRCT 125	Swivel wheel D. 125 mm in rubber								1		

All accessories include fixing screws when required



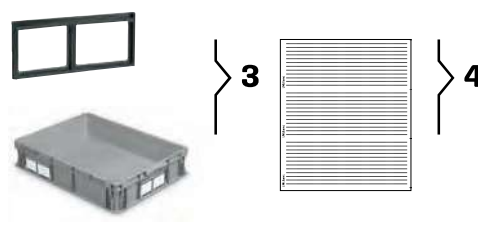

C	
Stacked edge height	310 mm
Usable stacked height / with lid	291 mm / 298 mm
Usable internal dimensions	755 x 555 x 306 H mm
Volume	130 L
Pieces per package / pallet	2 14
Package dimensions	820 x 620 x 655 H mm
Pallet dimensions	1200 x 800 x 2335 H mm
1	
Feet with fixing screws	100 H mm
Pièces par paquet	1
2	
Crossbar	25 H mm
Pieces per package	1
3	
Swivel wheel in rubber	diamètre 100/125 mm
Pièces par paquet	1

ARTICLE	SEPARATE LID	GR.	PACKAGING		UNIT PRICE €
			Qty. per pack.	Qty. per pallet	
1 AT 86SE 5101	■	1978	5	60	
AT 86SE 5207	■	2215	5	60	
AT 86SE 5401	■	2067	5	60	
2 SPRING 0099	Document holder spring		10		
3 AT LH64 5107	Label holders		10		
4 LB 21081 0325	A4 sheet with 3 labels		25		
5 AT WRBT 100	Swivel wheel in rubber w/brake D. 100 mm		1		
AT WRBT 125	Swivel wheel in rubber w/brake D. 125 mm		1		
6 AT WRCF 100	Swivel wheel in rubber D. 100 mm		1		
AT WRCF 125	Swivel wheel in rubber D. 125 mm		1		
7 AT WNBT 100	Swivel wheel in nylon w/brake D. 100 mm		1		
AT WNBT 125	Swivel wheel in nylon w/brake D. 125 mm		1		
8 AT WNCF 100	Fixed wheel in nylon D. 100 mm		1		
AT WNCF 125	Fixed wheel in nylon D. 125 mm		1		
9 AT WHBT 125	Swivel wheel non-marking rubber w/brake D. 125 mm		1		
10 AT WHCF 125	Fixed wheel non-marking rubber D. 125 mm		1		



 All accessories include fixing screws when required

DATASHEET

Separate lid	800 x 600 mm
1 Pieces per pack / pallet	 5  60
Package dimensions	800 x 600 x 150 H mm
Pallet dimensions	1200 x 800 x 860 H mm
Document holder spring	
2 Pieces per package	 10
Label holders	215 x 85 H mm
3 Pieces per package	 10
A4 sheet with 3 labels	210 x 81 H mm
4 Pieces per package	 25
Swivel wheel in rubber with brake D. 100 mm footprint 128 H mm	
5 Swivel wheel in rubber with brake D. 125 mm footprint 155 H mm	
Rubber fixed wheel diameter 100 mm - footprint 128 mm H	
6 Rubber fixed wheel diameter 125 mm - footprint 155 mm H	
Swivel wheel in nylon with brake diameter 100 mm footprint 128 H mm	
7 Swivel wheel in nylon with brake diameter 125 mm footprint 155 H mm	
Fixed wheel in nylon diameter 100 mm footprint 128 mm H	
8 Fixed wheel in nylon diameter 125 mm footprint 155 mm H	
Swivel wheel in non-marking rubber with brake diameter 125 mm - footprint 155 H mm	
9 Fixed wheel in non-marking rubber diameter 125 mm - footprint 155 H mm	
10	

iMilani srl reserves the right to alter the characteristics of products without notice. The values shown are nominal, with a +/- 1% tolerance for size, depending on the material, and a +/- 3% for weight.

Reinforced bottom
Load capacity 60 kg



C



1



Order 4 feet

2



Order 2 crossbars

3

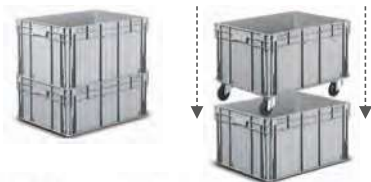

Order 4 wheels
AT WRCT 100/125
or alternatively those on
the opposite page

Accessories supplied mounted

iMilani srl reserves the right to alter the characteristics of products without notice. The values shown are nominal, with a +/- 1% tolerance for size, depending on the material, and a +/- 3% for weight.



ARTICLE	WALLS		BOTTOM			HANDLES		GR.	PACKAGING		UNIT PRICE €	
	Closed	Perforated	Closed	Perforated	Reinforced	Closed	Open		Qty. per pack.	Qty. per pallet		
AT 8643C 5101	■				■	■		6238	1	10		
C AT 8643C 5207	■				■	■		6986	1	10		
ECOGREEN ✓ AT 8643C 5401	■				■	■		6518	1	10		
ACCESSORIES												
AT FEET 5101	Foot							136	1			
1 AT FEET 5207	Order 4 pieces							152	1			
ECOGREEN ✓ AT FEET 5401								142	1			
AT RUNN 5101	Crossbar to be slotted under the feet AT FEET							382	1			
2 AT RUNN 5207	Order 2 pieces							428	1			
ECOGREEN ✓ AT RUNN 5401								400	1			
3 AT WRCT 100	Swivel wheel D. 100 mm in rubber								1			
AT WRCT 125	Swivel wheel D. 125 mm in rubber								1			

All accessories include fixing screws when required

C	
Stacked edge height	415 mm
Usable stacked height / with lid	396 mm / 403 mm
Usable internal dimensions	755 x 555 x 411 H mm
Volume	175 L
Pieces per package / pallet	1 10
Package dimensions	820 x 620 x 450 H mm
Pallet dimensions	1200 x 800 x 2240 H mm
1	
Feet with fixing screws	100 H mm
Pieces per package	1
2	
Crossbar	25 H mm
Pieces per package	1
3	
Swivel wheel in rubber	diamètre 100/125 mm
Pieces per package	1

800 x 600 mm H 430 mm



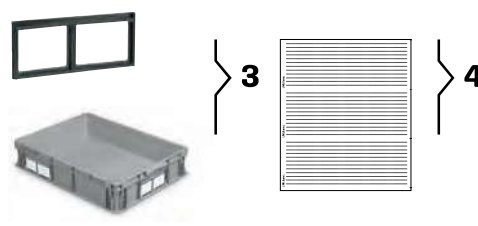

iMICUBE

ARTICLE	SEPARATE LID	GR.	PACKAGING		UNIT PRICE €
			Qty. per pack.	Qty. per pallet	
1 AT 86SE 5101	■	1978	5	60	  ECOGREEN
AT 86SE 5207	■	2215	5	60	
AT 86SE 5401	■	2067	5	60	
2 SPRING 0099	Document holder spring		10		
3 AT LH64 5107	Label holders		10		
4 LB 21081 0325	A4 sheet with 3 labels		25		
5 AT WRBT 100	Swivel wheel in rubber w/brake D. 100 mm		1		
AT WRBT 125	Swivel wheel in rubber w/brake D. 125 mm		1		
6 AT WRCF 100	Swivel wheel in rubber D. 100 mm		1		
AT WRCF 125	Swivel wheel in rubber D. 125 mm		1		
7 AT WNBT 100	Swivel wheel in nylon w/brake D. 100 mm		1		
AT WNBT 125	Swivel wheel in nylon w/brake D. 125 mm		1		
8 AT WNCF 100	Fixed wheel in nylon D. 100 mm		1		
AT WNCF 125	Fixed wheel in nylon D. 125 mm		1		
9 AT WHBT 125	Swivel wheel non-marking rubber w/brake D. 125 mm		1		
10 AT WHCF 125	Fixed wheel non-marking rubber D. 125 mm		1		



 All accessories include fixing screws when required

DATASHEET

Separate lid	800 x 600 mm
1 Pieces per pack / pallet	 5  60
Package dimensions	800 x 600 x 150 H mm
Pallet dimensions	1200 x 800 x 860 H mm
Document holder spring	
2 Pieces per package	 10
Label holders	215 x 85 H mm
3 Pieces per package	 10
A4 sheet with 3 labels	210 x 81 H mm
4 Pieces per package	 25
5 Swivel wheel in rubber with brake D. 100 mm footprint 128 H mm	
Swivel wheel in rubber with brake D. 125 mm footprint 155 H mm	
6 Rubber fixed wheel diameter 100 mm - footprint 128 mm H	
Rubber fixed wheel diameter 125 mm - footprint 155 mm H	
7 Swivel wheel in nylon with brake diameter 100 mm footprint 128 H mm	
Swivel wheel in nylon with brake diameter 125 mm footprint 155 H mm	
8 Fixed wheel in nylon diameter 100 mm footprint 128 mm H	
Fixed wheel in nylon diameter 125 mm footprint 155 mm H	
9 Swivel wheel in non-marking rubber with brake diameter 125 mm - footprint 155 H mm	
10 Fixed wheel in non-marking rubber diameter 125 mm - footprint 155 H mm	

iMilani srl reserves the right to alter the characteristics of products without notice. The values shown are nominal, with a +/- 1% tolerance for size, depending on the material, and a +/- 3% for weight.